

EARTH POSITIVE®

2026 Catalogue (EU)



Table of Contents

[Click on any product to go directly to its page](#)

Organic, Ethical & Climate Neutral Apparel4

T-shirts6

EP01	8
EP01L	16
EP01S	22
EP002	28
EP16	34
EP19	40
EP026	46
EP38	52
EP50	56
EP220	60
EP185	64
EP185L	70

Polos76

EP39	78
EP40	82

Hoodies and Sweatshirts86

EP301	88
EP302	96
EP303	104
EP304	110
EP305	116
EP306	122
EP307	126
EP309	130
EP310	134
EP311	138
EP311	140
EP312	142
EP314	146
EP316	152
EP400	156
EP400	158
EP400	160

EP540	162
EP550	166
EP552	170

Sweatpants, Shorts and Skirts..... 174

EP340	176
EP341	182
EP342	188
EP343	194
EP344	200

Children's Styles..... 204

EPJ01	206
EPJ301	212
EPJ304	218

Tote Bags 222

EP70	224
EP71	230
EP74	234
EP75	240
EP76	246
EP80	252
EP81	258
EP82	264

Main Collection Range Planner..... 270

New In Range Planner..... 272

Our Colours 274

Earth Positive®

Organic, Ethical & Climate Neutral Apparel



Sustainable manufacturing: 100% GOTS Certified Organic Cotton

We manufacture our products with minimal negative impact on the environment.

Starting with the sourcing of raw materials, we ensure full **traceability of all fibres**, choosing **100% GOTS certified organic cotton** in the Earth Positive® range. Our garments are made from organic cotton, hand-picked and grown without the use of harmful chemicals, ensuring healthy soil and farmer well-being

We are an active contributor to the International Working Group on the Global Organic Textile Standard (GOTS). We are certified under the **Global Organic Textile Standard**, Organic Content Standard and the Global Recycled Standard.



Yarns and Fabric

The quality of our yarns and fabrics is the foundation to delivering the **highest quality garments**.

We control the spinning process of almost seventy percent of all the yarns used in production as part of its vertically-integrated manufacturing structure, with the remainder being carefully sourced externally. All the yarns used by our company are fully combed and ring spun.

All the fabrics are knitted at our in-house facilities, and dyed with GOTS approved chemicals, using low-water and controlled waste discharge processes, certified to **OekoTex 100 Class I standard** and conforming to REACH.

Organic certified fabrics are dyed in our **zero-discharge dyehouse**, where all the water is recycled in a **closed-loop system**.

Climate neutral

Our factory is powered only by **clean renewable energy**, using wind turbines and solar panels, and our water is treated and reused with ZERO discharge, keeping local systems free from harmful chemicals.

Our carbon footprint is around 90% less than that of standard clothing producers.

In 2021 Earth Positive® achieved **DETOX TO ZERO** status. This means there is **zero discharge of hazardous chemicals (ZDHC)** in our fabrics processing plant. There is no discharge of liquid waste in the dye house as we operate a **closed-loop system** where all wastewater is purified and returned back to be used again.



Printing suitability

The **high quality surface finish**, our garments perform particularly well with digital direct-to-garment or DTG printing.

All our products are designed and **manufactured specifically for garment decorating**, and, with the exception of un-dyed bags, are suitable for all screen-printing techniques and all ink types, including discharge printing.

We strongly urge the use of ink types and printing processes with a low environmental impact, without phthalates or aromatic solvents, non-PVC, water-based, compliant with environmental and organic standards.



T-shirts



EP01

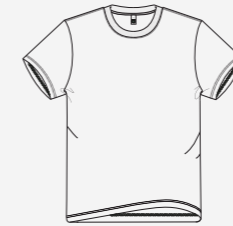

Earth Positive®
Jersey T-shirt

EP01L



Earth Positive®
Long Sleeve T-shirt

EP01S



Earth Positive®
Sleeveless T-shirt

EP002



Earth Positive®
Women's Premium Jersey T-shirt

EP16



Earth Positive®
Women's Rolled Sleeve T-shirt

EP19

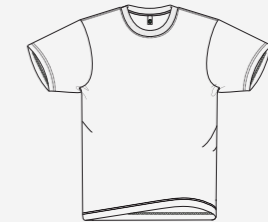

Earth Positive®
Oversized T-shirt

EP026

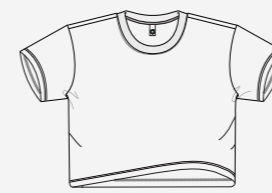

Earth Positive®
Women's Premium Boxy T-shirt

EP38

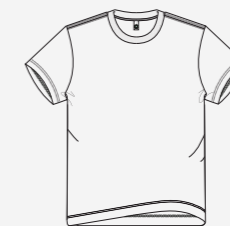

Earth Positive®
Heavy Jersey T-shirt

EP50



Earth Positive®
Oversized T-shirt

EP220



Earth Positive®
Heavy Jersey T-shirt

EP185

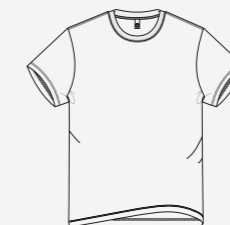

Earth Positive®
Premium Jersey T-shirt

EP185L



Earth Positive®
Premium Long Sleeve T-shirt

EP01

Earth Positive® Jersey T-shirt



There are T-shirts, and then there's the EP01. **A staple since 2007**, this is the style that put Earth Positive® on the map - and kept us there. Designed with a classic, unisex fit that works effortlessly on everyone, the EP01 isn't chasing trends - it's what other T-shirts chase.

What sets it apart? The technology behind the fabric. Unlike many tees that rely on enzyme washes to fake softness (which disappear after a few washes), the EP01's feel and performance come from the inside out through compact-spun yarn, a process we've perfected and others can't replicate. It's why the EP01 keeps its shape, feel, and integrity wash after wash. Quality doesn't wash out.

For printers and decorators, it's become a go-to blank. Easy to work with, reliable, and

consistent. That's why it's a favourite across bands, brands, and businesses that value durability and print performance.

On the sustainability front, EP01 leads with facts, not fluff. Made from **100% GOTS certified organic cotton**, with 90% CO2 reduction per T-shirt (around 6kg CO2 saved per each T-shirt). No polyester. No microplastics. No offsets. Just the real thing, done right.



[Back to Contents](#)

EP01

Earth Positive® Jersey T-shirt

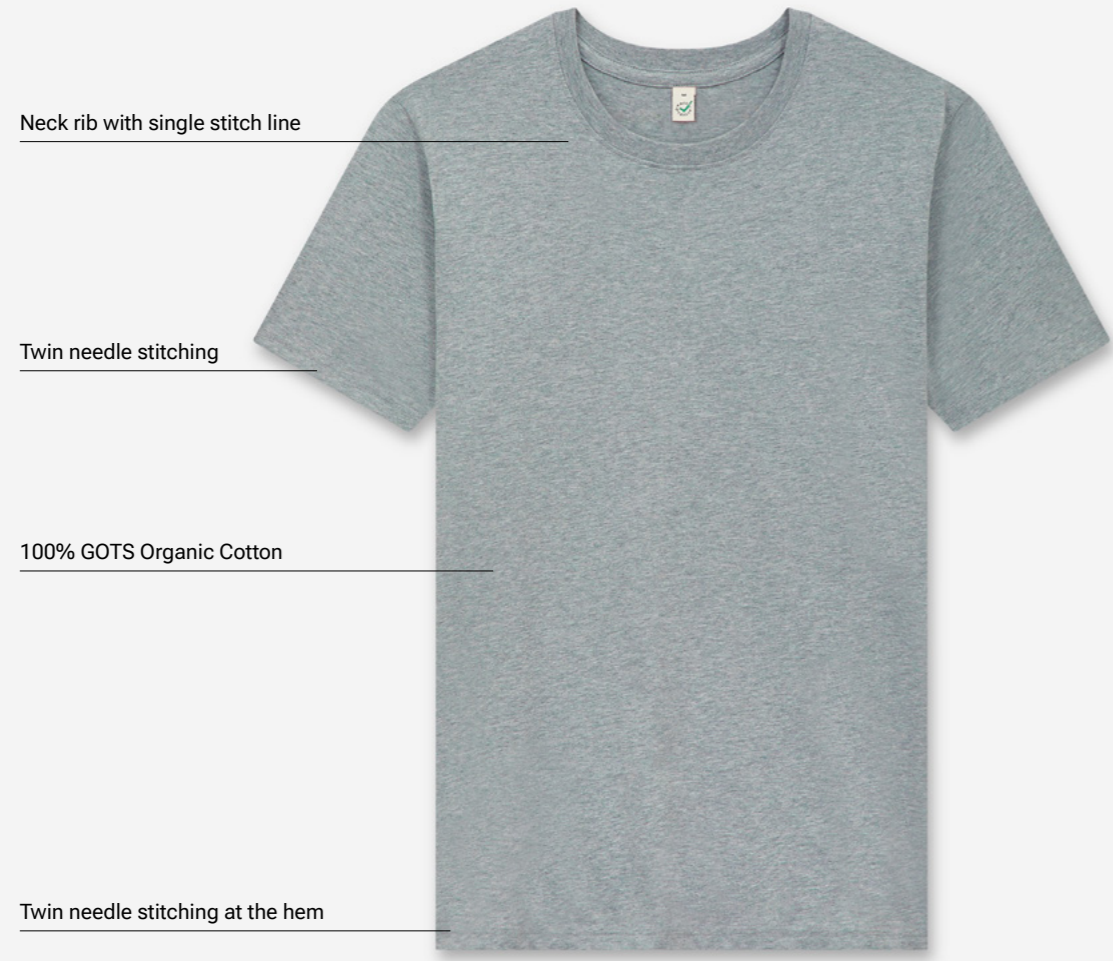

Fibre Composition / Yarn Type

100% GOTS Organic Cotton Compact Spun

Fibre Type / Weight

Jersey 4.6 oz/yd² 155 g/m²

Available Sizes

XS S M L XL 2XL 3XL 4XL 5XL

Origin

India

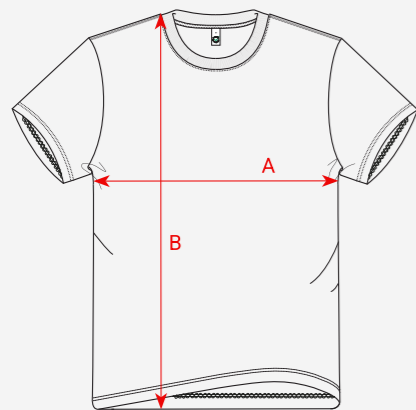

Size Spec

Size	Width (A)		Length (B)	
	cm	inch	cm	inch
XS	48	19	68	26¾
S	50	19¾	70	27½
M	53	21	72	28¾
L	56	22	74	29¾
XL	60	23½	76	30
2XL	64	25¼	78	30¾
3XL	68	26¾	80	31½
4XL	72	28¾	82	32¼
5XL	76	30	84	33



Ayo
Height 188 cm
Size M
Colour **Burnt Yellow**

Ana
Height 174 cm
Size XS
Colour **Stone Wash Denim**

EP01

Earth Positive® Jersey T-shirt



Black **BL**



White **WH**



Off White **WM**



Natural (Undyed) **NL**



Blush Pink **MP**



Sweet Pink **SL**



Red **RE**



Burgundy **BU**



Rust **RO**



Burnt Yellow **MA**



Light Blue **LB**



Bright Blue **BB**



Faded Denim **FDE**



Denim Blue **DE**



French Navy **FRNA**



Dark Navy **NA**



Slate Green **SLGR**



Sage Green **SAG**



Kelly Green **KE**



Bottle Green **BO**



Moss Green **MO**



Light Grey **GY**



Light Heather **LHE**



Light Charcoal **LCH**



Dark Charcoal **DCH**



Acid Black **ABL**



Tie Dye Rainbow **TD**

EP01

Stone Washed

Our premium Stone Washed garments offer a vintage feel and softened fit. They are rich in character and perfect for printing.

Our stone washed process is certified under Global Organic Textile Standard (GOTS).



Stone Washed Pink **SPK**



Stone Washed Burgundy **SBU**



Stone Washed Sage Green **SSAG**



Stone Washed Green **SGR**



Stone Washed Denim **SDE**



Stone Washed Grey **SGY**



Stone Washed Black **SBL**



EP01L

Earth Positive® Long Sleeve T-shirt



The EP01L is the long sleeve version of our iconic EP01, the T-shirt that built the Earth Positive® name. Made from lightweight 155 g/m2 organic cotton jersey, this unisex style offers the same **trusted fit, soft feel, and clean silhouette**, now with full-length sleeves for added versatility.

It's everything that makes the EP01 a best seller: breathable, durable, and designed to last wash after wash. We don't rely on chemical softeners; instead, we use compact-spun yarn technology to ensure the fabric feels good from the inside out.

For printers and brands, the EP01L is a dream to work with. Lightweight but stable, smooth but strong, it delivers consistent print results every time. Ideal for layering pieces, seasonal collections, or long-sleeve band merch.

Made from **100% GOTS certified organic cotton**, with no polyester, no microplastics, and no greenwashing. Just the same high-impact, low-impact promise you expect from Earth Positive®. The EP01L adds reach to your range sustainably.



[Back to Contents](#)

EP01L

Earth Positive® Long Sleeve T-shirt



Neck rib with single stitch line

100% GOTS Organic Cotton

Twin needle stitching at body and sleeve hem



Fibre Composition / Yarn Type

100% GOTS Organic Cotton Compact Spun

Fibre Type / Weight

Jersey 4.6 oz/yd² 155 g/m²

Available Sizes

XS S M L XL 2XL 3XL

Origin

India

Size Spec

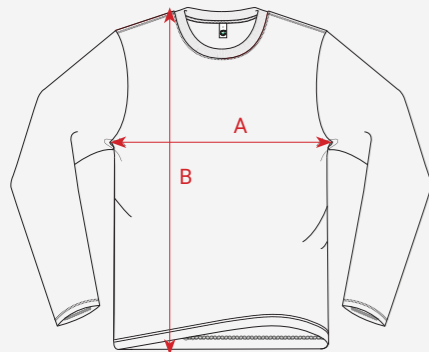

Size	Width (A)		Length (B)	
	cm	inch	cm	inch
XS	47	18½	68	26¾
S	50	19¾	70	27½
M	53	21	72	28¾
L	56	22	74	29¾
XL	60	23¾	76	30
2XL	64	25¾	78	30¾
3XL	68	26¾	80	31½



Ben
Height 188 cm
Size M
Colour Denim Blue

Ana
Height 174 cm
Size XS
Colour Light Heather Grey

EP01L

Earth Positive® Long Sleeve T-shirt



Black BL



White WH



Faded Denim FDE



Denim Blue DE



French Navy FRNA



Light Heather LHE



Stone Washed Black SBL



Ruslan
Height 185 cm
Size M

Colour Stone Washed Black

EP01S

Earth Positive® Sleeveless T-shirt



The EP01S takes everything that made the EP01 iconic and strips it back - literally. A sleeveless adaptation of our most loved T-shirt, it's built for **comfort, breathability, and effortless style**. Lightweight at 155 g/m2, it's crafted from our signature **100% GOTS certified organic cotton jersey** soft to the touch, but made to last.

Designed with a unisex fit, the EP01S features a ribbed neckline with single-needle stitching, cleanly finished armholes with self-fabric taping for reinforcement, and a twin needle stitched hem for long-lasting structure. It's a go-to option for warmer days, active settings, or simply a more relaxed look.

Sustainability is built in, not tacked on. Like all Earth Positive® products, the EP01S is made with **no polyester, no microplastics, and no greenwashing**.

Whether your customer is looking for premium blanks to print on or a low-impact essential to wear as-is, this piece delivers.

Available in White, Black, and Stone Washed Black classic shades that work across markets and moods.



[Back to Contents](#)

EP01S

Earth Positive® Sleeveless T-shirt



Fibre Composition / Yarn Type

100% GOTS Organic Cotton Compact Spun

Fibre Type / Weight

Jersey 4.6 oz/yd² 155 g/m²

Available Sizes

XS S M L XL 2XL 3XL

Origin

India

Size Spec

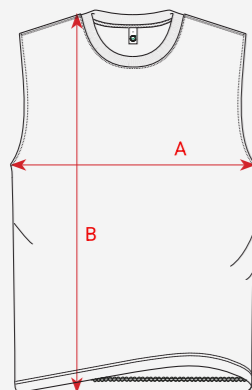

Size	Width (A)		Length (B)	
	cm	inch	cm	inch
XS	48	18¾	68	26¾
S	50	19¾	70	27½
M	53	21	72	28¾
L	56	22	74	29¼
XL	60	23½	76	30
2XL	64	25¼	78	30¾
3XL	68	26¾	80	31½

Ruslan
Height 185 cm
Size M
Colour Stone Washed Black

EP01S

Earth Positive® Sleeveless T-shirt



Black **BL**



White **WH**



Stone Washed Black **SBL**



EP002

Earth Positive® Women's Premium Jersey T-shirt



EP002 is the updated women's version of our classic EP02 Earth Positive® T-shirt - now in a premium 185 g/m2 organic cotton jersey for a softer hand feel and a more substantial look.

This style has been redesigned for a **modern, boxy silhouette** that flatters and fits comfortably. Slightly longer sleeves and a raised neckline add to the elevated finish, making it a refined essential in any sustainable wardrobe.

Made from 100% GOTS certified organic cotton, EP002 offers **all the benefits of Earth Positive® no polyester, no microplastics, and a significant CO2 reduction.** The premium fabric also delivers an excellent print surface, making it ideal for retail, merchandise, and fashion-led collections.

Finished with our Earth Positive® 'green tick' label at the centre back, EP002 communicates authentic quality and environmental responsibility at a glance.



EP002

Earth Positive® Women's Premium Jersey T-shirt

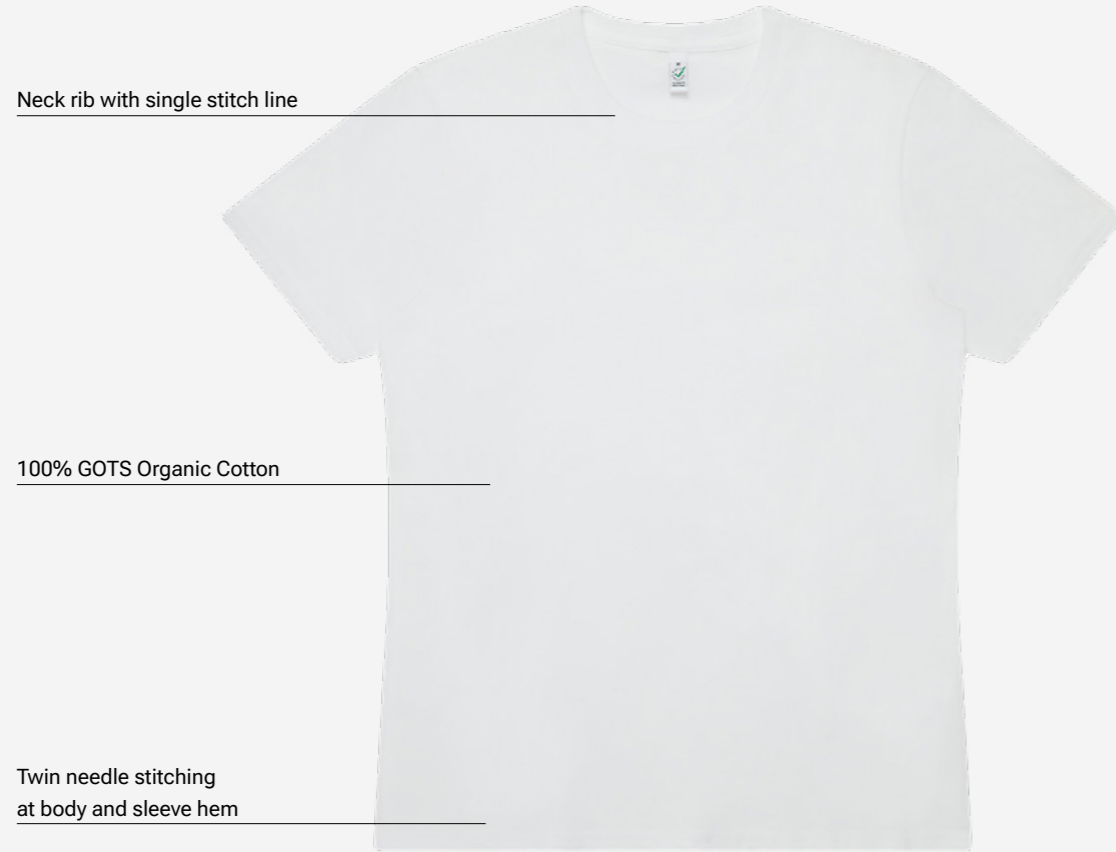

Fibre Composition / Yarn Type

100% GOTS Organic Cotton Compact Spun

Fibre Type / Weight

Jersey 5.5 oz/yd² 185 g/m²

Available Sizes

XS S M L XL 2XL

Origin

India

Size Spec

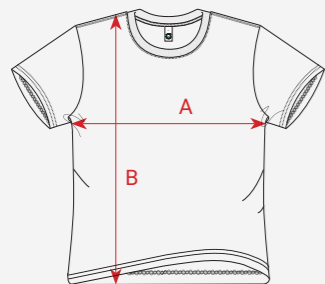

Size	Width (A)		Length (B)	
	cm	inch	cm	inch
XS	45	17½	56.5	22¼
S	47.5	18½	58	22¾
M	50	19½	59.5	23½
L	52.5	20½	61	24
XL	55	21½	62.5	24½
2XL	57.5	22½	64	25¼



Devon
Height 173 cm
Size S
Colour **Stone Washed Black**

EP002

Earth Positive® Women's Premium Jersey T-shirt



Black BL



White WH



EP16

Earth Positive® Women's Rolled Sleeve T-shirt



The EP16 brings a modern edge to a classic silhouette, with rolled sleeves that offer a relaxed, contemporary look. Crafted from 100% GOTS-certified organic cotton, this style combines effortless wearability with certified sustainability.

Cut in a flattering women's fit, the EP16 is soft, breathable, and ideal for casual **collections, retail, or branded merchandise.**

Finished with the signature Earth Positive® green tick label at the centre back neck, it stands as a clear statement of ethical production and low-impact manufacturing. A simple update with strong visual appeal, made to wear well and print beautifully.



EP16

Earth Positive® Women's Rolled Sleeve T-shirt



Relaxed neck

Ribbed neck

Roll Sleeve

100% GOTS Organic Cotton

Twin needle stitching at curved hem



Fibre Composition / Yarn Type

100% GOTS Organic Cotton Compact Spun

Fibre Type / Weight

Jersey 4.6 oz/yd² 155 g/m²

Available Sizes

XS S M L XL 2XL

Origin

India

Size Spec

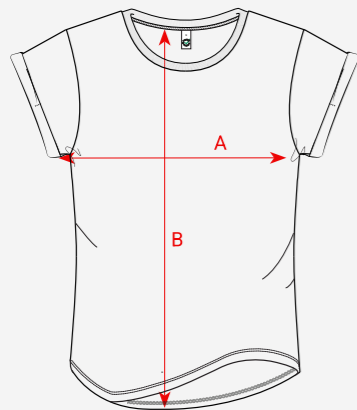

Size	Width (A)		Length (B)	
	cm	inch	cm	inch
XS	44	17½	61	24
S	46	18¼	63	24¾
M	49	19¼	65	25½
L	52	20½	67	26¼
XL	55	20¾	69	27¼
2XL	58	22¾	71	30



Ana
Height 174 cm
Size S
Colour Light Olive

EP16

Earth Positive® Women's Rolled Sleeve T-shirt



Black **BL**



White **WH**



Light Heather **LHE**



Miami Pink **PR**



Red **RE**



Denim Blue **DE**



French Navy **FRNA**



Sage Green **SAG**



Light Olive **PGR**



Acid Black **ABL**



Faded Burgundy (Berry) **BE**



Stone Washed



Stone Washed Pink **SPK**



Stone Washed Burgundy **SBU**



Stone Washed Sage Green **SSAG**



Stone Washed Green **SGR**



Stone Washed Denim **SDE**



Stone Washed Grey **SGY**



Stone Washed Black **SBL**

EP19

Earth Positive® Oversized T-shirt



A bold silhouette built for modern streetwear, the EP19 brings an oversized fit to the Earth Positive® range. Designed with extra volume through the body and sleeves, this style delivers a relaxed, contemporary look ideal for fashion, merch, and elevated casualwear.

Made from 185 g/m² premium weight, **100% Gots certified organic cotton**, it combines substantial feel with breathable comfort perfect for oversized prints or standout styling.

Finished with the signature Earth Positive® green tick label at the centre back, EP19 communicates its ethical and low-carbon credentials with clarity and confidence.



[Back to Contents](#)

EP19

Earth Positive® Oversized T-shirt



Relaxed neck

Neck rib with single stitch line

Dropped shoulder



100% GOTS Organic Cotton

Oversized fit

Twin needle stitching at the hem

Fibre Composition / Yarn Type

100% GOTS Organic Cotton Compact Spun

Fibre Type / Weight

Jersey 6.5 oz/yd² 185 g/m²

Available Sizes

XS S M L XL 2XL 3XL

Origin

India

Size Spec

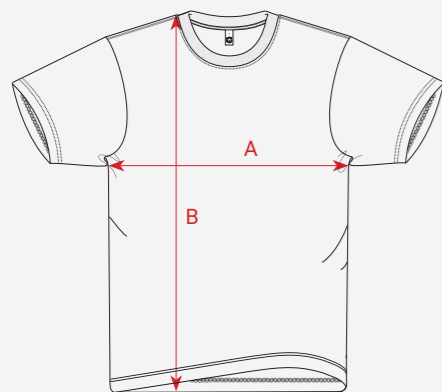

Size	Width (A)		Length (B)	
	cm	inch	cm	inch
XS	51	20	73	28¾
S	54	21¼	75	29½
M	57	22½	77	30¼
L	60	23½	79	31
XL	63	24¾	81	32
2XL	66	26	83	32¾
3XL	69	27¼	85	33½



Ben
Height 188 cm
Size M
Colour White

EP19

Earth Positive® Oversized T-shirt



Black **BL**



White **WH**



Off White **WM**



Light Beige **SA**



Bones **BON**



Miami Pink **PR**



Mustard **MUS**



Denim Blue **DE**



Blue Dusk **BD**



Light Grey **GY**



Light Heather **LHE**



Faded Black Deep Grey **FBDG**



Faded Olive Black **FBL**



Stone Washed Black **SBL**



Stone Washed Sage Green **SSAG**



Ben
Height **188 cm**
Size **M**
Colour **Miami Pink**

EP026

Earth Positive® Women's Premium Boxy T-shirt



The EP026 is a modern, boxy-fit women's T-shirt crafted from 100% GOTS-certified organic cotton in a premium 185 g/m² jersey. With a **cropped silhouette and structured shape**, it's a fresh take on a classic, ideal for retail collections that value both style and sustainability.

Designed with a wider body and shorter length, slightly extended sleeves, and a higher neckline, the EP026 delivers a **contemporary fit with everyday wearability**. It offers a clean, elevated surface for decoration, making it a favourite among brands focused on quality and detail.

Finished with the Earth Positive® 'green tick' label at the back neck, this piece speaks clearly to conscious production and ethical sourcing. Bold, boxy, and better for the planet.



[Back to Contents](#)

EP026

Earth Positive® Women's Premium Boxy T-shirt



Relaxed neck

Neck rib with single stitch line

Dropped shoulder

100% GOTS Organic Cotton

Boxy fit

Twin needle stitching at the hem



Fibre Composition / Yarn Type

100% GOTS Organic Cotton Compact Spun

Fibre Type / Weight

Jersey 5.5 oz/yd² 185 g/m²

Available Sizes

S M L

Origin

India

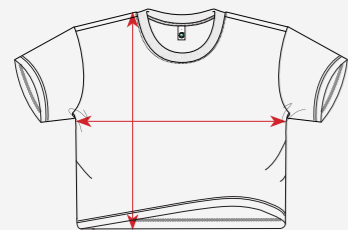

Size Spec

Size	Width (A)		Length (B)	
	cm	inch	cm	inch
S	51	20	50	19¾
M	54	21¼	51.5	20¼
L	57	22½	53	20¾



Devon

Height 173 cm

Size S

Colour **Stone Washed Black**

EP026

Earth Positive® Women's Premium Boxy T-shirt



Black **BL**



White **WH**



Stone Washed Black **SBL**



Winnie
Height **175 cm**
Size **S**
Colour **White**

EP38

Earth Positive® Heavy Jersey T-shirt



When premium weight meets conscious design, you get the EP38 Earth Positive®'s heaviest T-shirt, made for those who want substance without compromise.

Crafted from dense 220 g/m² organic cotton jersey, this tee offers a **structured silhouette** and a rich, substantial feel that stands out both in hand and on the body.

The **heavyweight** fabric provides a clean, stable canvas for decoration making it a go-to choice for printers and brands that want high-impact results. Whether worn plain or printed, the EP38 holds its shape and integrity wash after wash, while delivering comfort and durability in equal measure.



EP38

Earth Positive® Heavy Jersey T-shirt



Black **BL**



White **WH**



French Navy **FRNA**



Bottle Green **BO**



Storm Grey **STG**

Fibre Composition / Yarn Type

100% GOTS Organic Cotton Compact Spun

Fibre Type / Weight

Jersey 6.5 oz/yd² 220 g/m²

Available Sizes

XS S M L XL 2XL 3XL

Origin

India

Size Spec

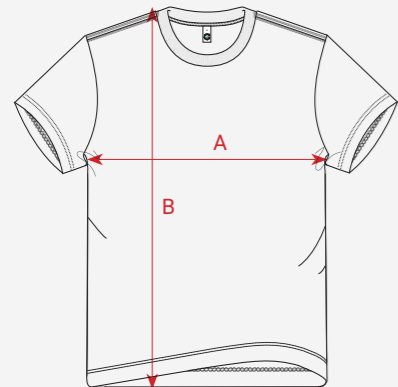

Size	Width (A)		Length (B)	
	cm	inch	cm	inch
XS	48.5	18¾	68	26¾
S	51.5	20¼	70	27½
M	54.5	21½	72	28¾
L	57.5	22½	74	29¼
XL	60.5	23¾	76	30
2XL	63.5	25	78	30¾
3XL	66.5	26¼	80	31½

EP50

Earth Positive® Heavy Boxy T-shirt



The EP50 is a premium heavyweight t-shirt designed for comfort, style, and sustainability. Crafted from 100% GOTS certified organic cotton (220 g/m²), it offers a substantial feel with a boxy, oversized fit for a contemporary silhouette.

Featuring a wide neck rib, herringbone back neck tape, and twin-needle stitching on the sleeves and hem, it's built for lasting quality and structure.

Finished with Earth Positive® branded labels, this classic black and white duo delivers effortless style with a responsible edge.



EP50

Earth Positive® Heavy Boxy T-shirt



Black BL

White WH

Fibre Composition / Yarn Type

100% GOTS Organic Cotton Compact Spun

Fibre Type / Weight

Jersey 6.5 oz/yd² 220 g/m²

Available Sizes

XS S M L XL 2XL 3XL

Origin

India

Size Spec

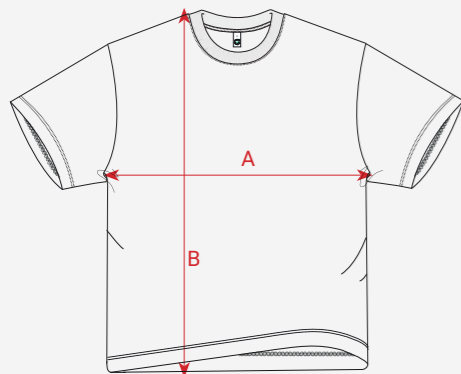

Size	Width (A)		Length (B)	
	cm	inch	cm	inch
XS	55.5	21¾	69	27¼
S	58	22¾	71	28
M	60.5	23¾	73	28¾
L	63	24¾	74	29½
XL	65.5	25¾	77	30¼
2XL	68	26¾	79	31
3XL	70.5	27¾	80	31½

EP220

Earth Positive® Women's Heavy Boxy T-shirt



The EP220 is the women's counterpart to our new EP50, offering the same premium heavyweight feel with a shape refined for a feminine fit. Made from 100% GOTS certified organic cotton (220 g/m²), it delivers comfort, structure, and a distinctly modern silhouette.

A slightly shorter front length and a subtly deeper neckline create a flattering, relaxed look without compromising on coverage. Designed with a wide neck rib, durable twin-needle stitching, and herringbone back neck tape, it balances everyday wearability with long-lasting quality.

Available in classic Black and White and finished with Earth Positive® branded labels, the EP220 gives effortless style a responsible upgrade - better for people, better for the planet.



[Back to Contents](#)

EP220

Earth Positive® Women's Heavy Boxy T-shirt



Black BL

White WH

Fibre Composition / Yarn Type

100% GOTS Organic Cotton Compact Spun

Fibre Type / Weight

Jersey 6.5 oz/yd² 220 g/m²

Available Sizes

XS S M L XL 2XL

Origin

India

Size Spec

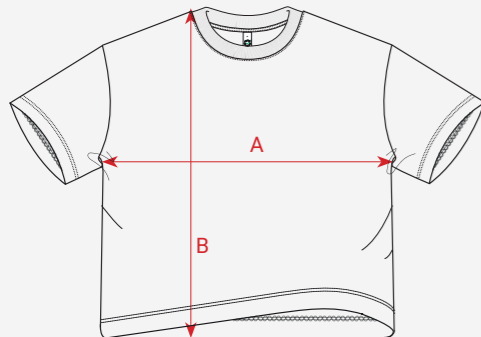

Size	Width (A)		Length (B)	
	cm	inch	cm	inch
XS	54.5	21½	55	27½
S	57	22½	56	22
M	59.5	23½	58	22¾
L	62	24½	60	23½
XL	64.5	25½	62	24½
2XL	67	26½	63	24¾

EP185

Earth Positive® Premium Jersey T-shirt



EP185 is the refined sibling of our iconic EP01, the same classic, unisex fit that flatters everyone, but made in a **premium 185 g/m²** Organic Cotton that elevates the everyday T-shirt.

Made from 100% GOTS certified organic cotton, the EP185 contains no polyester and no microplastics. It's not just a better T-shirt, it's the most sustainable choice you can make, with a carbon footprint that's up to 90% lower than conventional alternatives.

This isn't softness that washes out. The **premium finish** comes from the fibre itself, thanks to the advanced spinning technology we've developed over decades. Unlike other tees that rely on enzyme washes to fake a soft handfeel, the EP185 feels good from the start and stays that way.

For brands, bands, and printers, it's a go-to blank: high-quality, consistent, and easy to decorate. But what really sets it apart is the balance. It's a premium T-shirt at the best possible price and the most **ethical, traceable, and sustainable** option on the market.



EP185

Earth Positive® Premium Jersey T-shirt

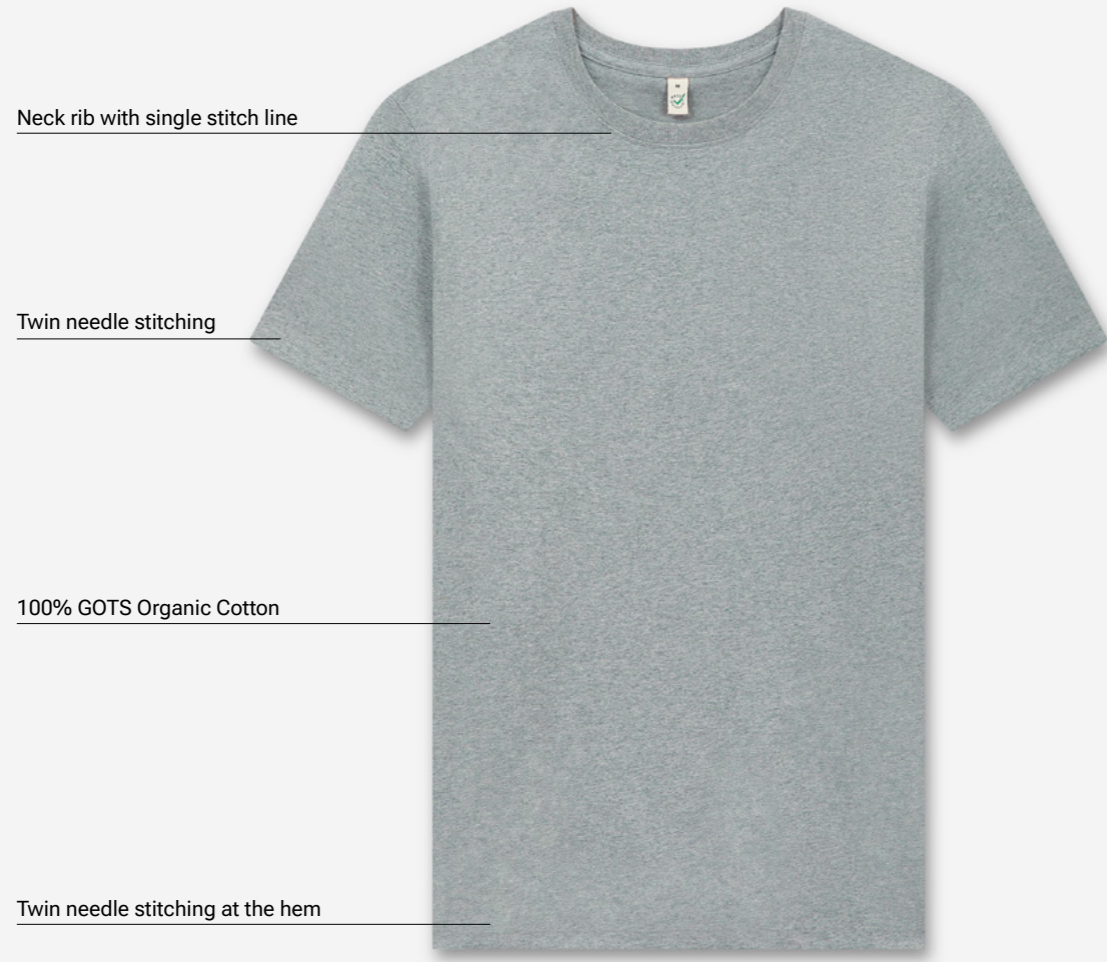

Fibre Composition / Yarn Type

100% GOTS Organic Cotton Compact Spun

Fibre Type / Weight

Jersey 5.5 oz/yd² 185 g/m²

Available Sizes

XS S M L XL 2XL 3XL

Origin

India

Size Spec

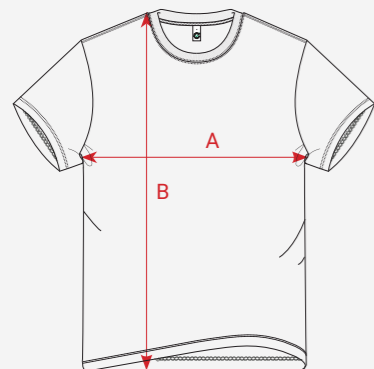

Size	Width (A)		Length (B)	
	cm	inch	cm	inch
XS	47	18½	68	26¾
S	50	19¾	70	27½
M	53	20¾	72	28¾
L	56	22	74	29¾
XL	60	23½	76	30
2XL	64	25¼	78	30¾
3XL	68	26¾	80	31½

Ayo
Height 188 cm
Size M
Colour Faded Khaki

EP185

Earth Positive® Premium Jersey T-shirt



Black **BL**



White **WH**



Ready For Dye **RFD**



Light Beige **SA**



Bone **BON**



Miami Pink **PR**



Cherry Red **CHRE**



Denim Blue **DE**



French Navy **FRNA**



Faded Blue (Blue Dusk) **BD**



Light Olive **PGR**



Forest Green **FGR**



Brown **BR**



Sport Grey **SG**



Light Heather **LHE**



Dark Heather **DHE**



Faded White **FWH**



Faded Pink **FPK**



Faded Khaki **FKH**



Faded Mustard **FMU**



Faded Brown **FBR**



Faded Purple Haze **FPH**



Faded Navy **FNA**



Faded Black Deep Grey **FBDG**



Faded Olive Black **FBL**

EP185L

Earth Positive® Premium Long Sleeved T-shirt



Introducing the EP185L the long-sleeved evolution of our best-selling premium tee, built for cooler days and conscious collections. Made from 185 g/ m² certified organic cotton, this heavyweight jersey fabric delivers a **structured feel with a smooth surface**, perfect for clean, high-impact prints.

Designed with the same flattering unisex fit as the EP185, the EP185L brings extra versatility to your range while maintaining all the key features: **premium weight, superior printability, and complete sustainability**. No polyester. No blends. Just 100% GOTS certified organic cotton from seed to stitch.

The distinctive Earth Positive® back neck tab adds value and visibility. It's more than a label it's your built-in brand story, communicating the product's

sustainability credentials clearly and confidently to customers and end users alike.

Ideal for music merch, streetwear drops, and elevated brand basics, the EP185L is premium where it matters most in quality, performance, and environmental impact.



[Back to Contents](#)

EP185L

Earth Positive® Premium Long Sleeved T-shirt



Fibre Composition / Yarn Type

100% GOTS Organic Cotton Compact Spun

Fibre Type / Weight

Jersey 5.5 oz/yd² 185 g/m²

Available Sizes

XS S M L XL 2XL 3XL

Origin

India

Size Spec

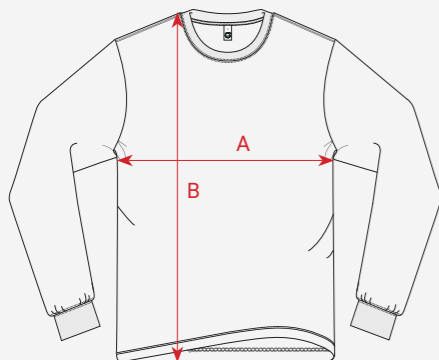

Size	Width (A)		Length (B)	
	cm	inch	cm	inch
XS	47	18½	68	26¾
S	50	19¾	70	27½
M	53	20¾	72	28¾
L	56	22	74	29¾
XL	60	23¾	76	30½
2XL	64	25¼	78	30¾
3XL	68	26¾	80	31½



Ayo
Height 188 cm
Size M
Colour Bone

Thais
Height 178 cm
Size XS
Colour French Navy

EP185L

Earth Positive® Premium Long Sleeved T-shirt



Black BL



White WH



Ready For Dye RFD



Light Beige SA



Bone BON



French Navy FRNA



Faded White FWH



Faded Pink FPK



Faded Khaki FKH



Faded Mustard FMU



Faded Brown FBR



Faded Blue BD



Faded Navy FNA



Faded Olive Black FBL



Polos



EP39



Earth Positive®
Jersey Polo Shirt

EP40



Earth Positive®
Piqué Polo Shirt

EP39

Earth Positive® Jersey Polo Shirt



A smart-casual essential made sustainably. The EP39 polo is crafted from 220 g/m² 100% GOTS certified organic cotton jersey, offering a soft hand-feel with breathable, natural comfort no synthetics, no microplastics.

Tailored for versatility, this style features a two-button placket, matching collar and sleeve hems, and side vents for improved ease of movement and a clean silhouette.

Finished with the Earth Positive® 'green tick' logo at the centre back, the EP39 combines everyday function with verified ethical and low-carbon production **a trusted staple for uniforms, merchandise, and retail alike.**



EP39

Earth Positive® Jersey Polo Shirt



Rib collar

Double button placket

Ribbed sleeve cuff

100% GOTS Organic Cotton

Classic fit

Side vent detail



Black BL

Fibre Composition / Yarn Type

100% GOTS Organic Cotton Compact Spun

Fibre Type / Weight

Jersey 6.5 oz/yd² 220 g/m²

Available Sizes

S M L XL 2XL

Origin

India

Size Spec

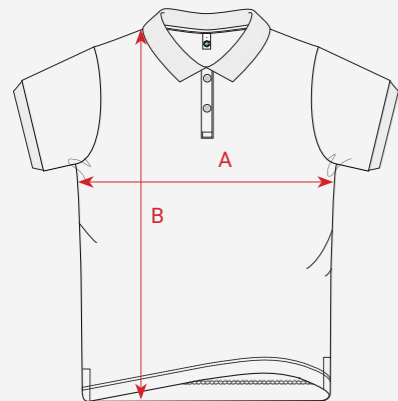

Size	Width (A)		Length (B)	
	cm	inch	cm	inch
S	51	20	72	28½
M	54	21¼	74	29¼
L	57	22½	76	30
XL	60	23½	78	30¾
2XL	63	24¾	80	31½

EP40

Earth Positive® Piqué Polo Shirt



A classic silhouette, elevated with substance and sustainability. The EP40 is made from 240 g/m² 100% organic cotton piqué, offering a textured, breathable fabric with timeless appeal.

Designed with a two-button placket, coordinated collar and sleeve detailing, and side vents at the hem for comfort and movement. A spare button is included inside for practicality.

Finished with the Earth Positive® 'green tick' logo at the centre back, the EP40 combines trusted style with a certified low-impact supply chain ideal for branded merchandise, uniforms, and retail collections seeking **long-term quality and ethical value.**



EP40

Earth Positive® Piqué Polo Shirt

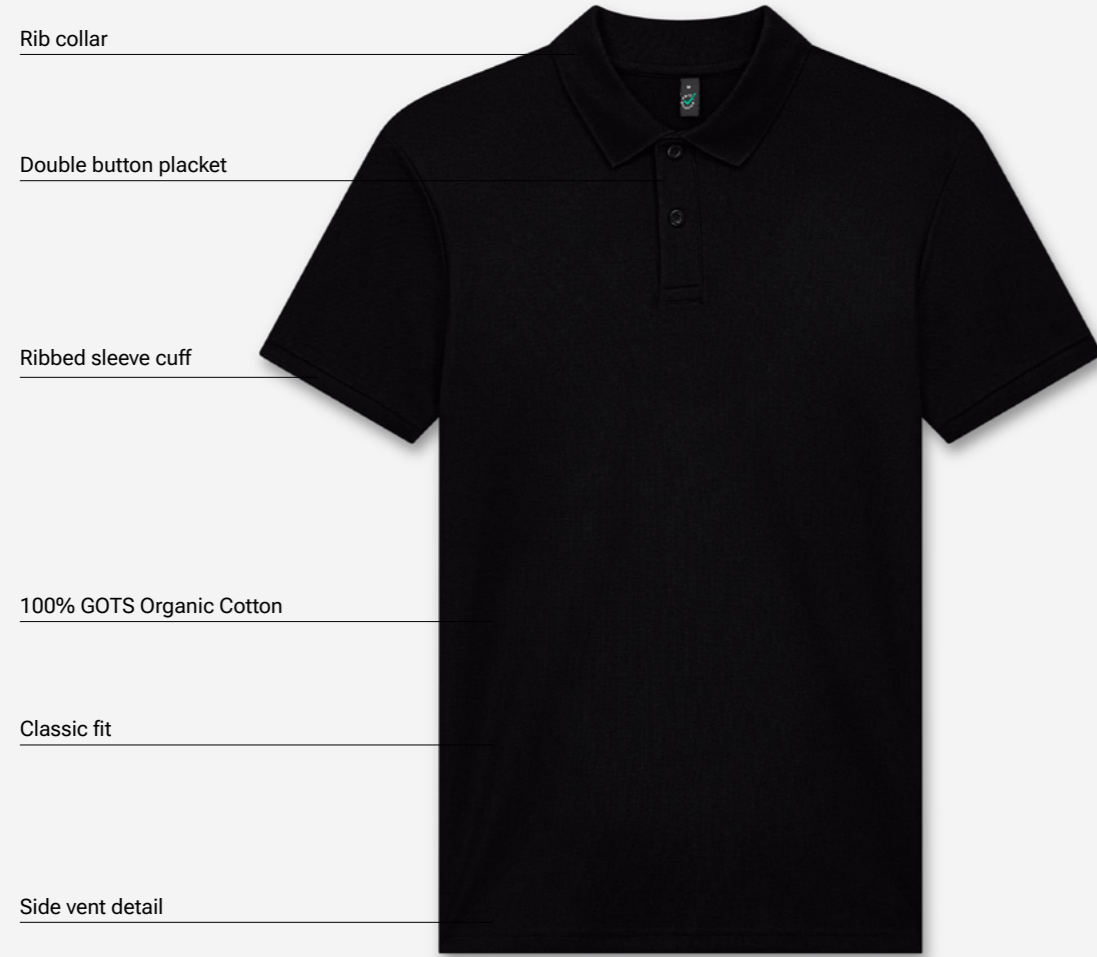

Black BL

Fibre Composition / Yarn Type

100% GOTS Organic Cotton Piqué Compact Spun

Fibre Type / Weight

Piqué 7 oz/yd² 240 g/m²

Available Sizes

S M L XL 2XL

Origin

India

Size Spec

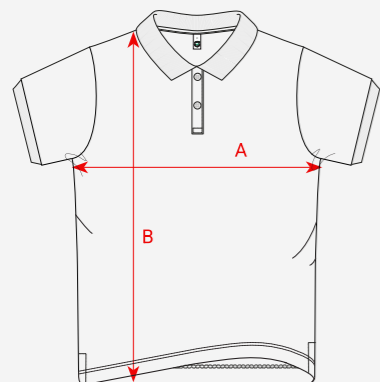

Size	Width (A)		Length (B)	
	cm	inch	cm	inch
S	51	20	72	28½
M	54	21¼	74	29¼
L	57	22½	76	30
XL	60	23½	78	30¾
2XL	63	24¾	80	31½

Hoodies and Sweatshirts



EP301



Earth Positive® Pullover Hoodie

EP302

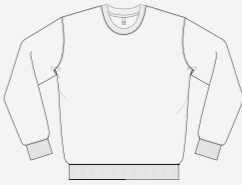

Earth Positive® Sweatshirt

EP303



Earth Positive® Full Zip Hoodie

EP304



Earth Positive® Half Zip Hoodie

EP305



Earth Positive® Mock Neck Sweatshirt

EP306



Earth Positive® Bomber Jacket Hoodie

EP309



Earth Positive® Sleeveless Full Zip Hoodie

EP310



Earth Positive® Shadow Hoodie

EP312

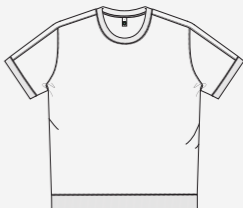

Earth Positive® Short sleeve Sweatshirt

EP314



Earth Positive® Women's Half Zip Hoodie

EP540



Earth Positive® Super Heavy Hoodie

EP552



Earth Positive® Storm Flap Hoodie

EP301

Earth Positive® Pullover Hoodie



There are hoodies, and then there's the EP301. With a thoughtfully designed silhouette, modern proportions and a luxuriously soft 300 g/m² fleece, the EP301 is made entirely from **100% GOTS certified organic cotton**. No polyester. No microplastics.

What makes it different? It's the process. Unlike other hoodies that rely on heavy surface treatments to feel soft, the EP301 is engineered from the yarn up. The technology behind the fabric gives it lasting softness and structure without relying on finishes that fade after the first few wears. The result is a **hoodie that feels as good as it looks for longer**.

Available in solid and **Stone Washed** colours, the EP301 speaks directly to a new generation of

environmentally conscious wearers, Gen-Z and Millennials who want substance behind the style.

For printers and brands, it's a dream to decorate: smooth, stable, and always reliable. And for the planet? **Every hoodie saves an average of 18kg of CO² compared to conventional alternatives.**



[Back to Contents](#)

EP301

Earth Positive® Pullover Hoodie



Fibre Composition / Yarn Type

100% GOTS Organic Cotton Compact Spun

Fibre Type / Weight

Brushed Fleece 3-ply 8.9 oz/yd² 300 g/m²

Available Sizes

XS S M L XL 2XL 3XL

Origin

India

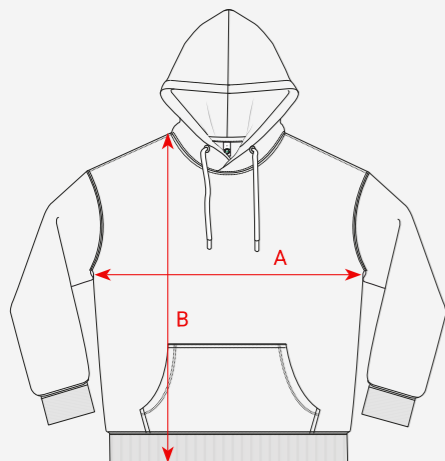

Size Spec

Size	Width (A)		Length (B)	
	cm	inch	cm	inch
XS	53.5	21	61.8	27
S	56.5	22¼	71.5	28¼
M	59.5	23¼	73.5	29
L	62.5	24½	75.5	29¾
XL	65.5	25¾	77.5	30½
2XL	68.5	27	79.5	31¼
3XL	71.5	28¼	80.5	31¾



Johan
Height 184 cm
Size M
Colour Faded Khaki

EP301

Earth Positive® Pullover Hoodie



Black **BL**



White **WH**



Ready For Dye **RFD**



Light Beige **SA**



Bone **BON**



Miami Pink **PR**



Cherry Red **CHRE**



Burnt Yellow **MA**



Denim Blue **DE**



French Navy **FRNA**



Blue Dust **BD**



Forest Green **FGR**



Light Grey **GY**



Light Heather **LHE**



Dark Heather **DHE**



Light Charcoal **LCH**



Faded White **FWH**



Faded Pink **FPK**



Faded Burgundy (Berry) **BE**



Faded Khaki **FKH**



Faded Mustard **FMU**



Faded Brown **FBR**



Faded Navy **FNA**



Faded Olive Black **FBL**



Faded Black Deep Grey **FBDG**

EP301

Stone Washed



Stone Washed Pink **SPK**



Stone Washed Burgundy **SBU**



Stone Washed Sage Green **SSAG**



Stone Washed Green **SGR**



Stone Washed Denim **SDE**



Stone Washed Grey **SGY**



Stone Washed Black **SBL**



EP302

Earth Positive® Sweatshirt



A sweatshirt is a sweatshirt - until it's the EP302. **Built for comfort, designed for print, and made to last**, this is our premium crewneck reinvented for a new era of sustainable apparel.

Crafted from **100% GOTS certified organic cotton fleece** and weighing in at 300 g/m², the EP302 combines substance with softness. There's no polyester here - just premium fibre, spun and finished using superior technology that makes it incredibly smooth, stable, and perfect for print. No pilling, no harsh washes, just long-lasting quality baked into every thread.

What makes the EP302 different is what you don't see. No microplastics. No offsets. No shortcuts. Just **traceable, transparent, low-impact production**, with a drastically lower carbon footprint

than conventional sweatshirts. It's the cleaner, smarter alternative that doesn't compromise on style or performance.

This is the blank trusted by brands, creatives, and music merch legends alike. Soft to wear, strong to last, and easy to print. **It's where comfort meets credibility - and it's what sustainable fashion should feel like.**



[Back to Contents](#)

EP302

Earth Positive® Sweatshirt



Fibre Composition / Yarn Type

100% GOTS Organic Cotton Compact Spun

Fibre Type / Weight

Brushed Fleece 3-ply 8.9 oz/yd² 300 g/m²

Available Sizes

XS S M L XL 2XL 3XL

Origin

India

Size Spec

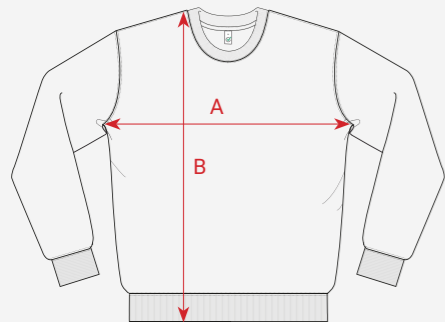

Size	Width (A)		Length (B)	
	cm	inch	cm	inch
XS	50	19¾	66.5	26¼
S	53	20¾	69.5	27¼
M	56	22	72.5	28½
L	59	23¾	74.5	29¼
XL	62	24¾	76.5	30
2XL	65	25½	78.5	31
3XL	68	26¾	80.5	31¾

Length (B): The length of EP302 XL, 2XL, 3XL has been updated in production. Prior to March 2025 production the old lengths measured XL 75.5, 2XL 76.5, 3XL 76.5.



Marlowe
 Height 190 cm
 Size M
 Colour Stone Washed Grey

Greta
 Height 173 cm
 Size XS
 Colour Stone Washed Burgundy

EP302

Earth Positive® Sweatshirt



Black **BL**



White **WH**



Ready For Dye **RFD**



Faded White **FWH**



Faded Pink **FPK**



Faded Burgundy (Berry) **BE**



Light Beige **SA**



Bone **BON**



Miami Pink **PR**



Faded Khaki **FKH**



Faded Mustard **FMU**



Faded Brown **FBR**



Cherry Red **CHRE**



Burnt Yellow **MA**



Denim Blue **DE**



Faded Navy **FNA**



Faded Black Deep Grey **FBDG**



Faded Olive Black **FBL**



French Navy **FRNA**



Forest Green **FGR**



Light Grey **GY**



Light Heather **LHE**



Dark Heather **DHE**



Light Charcoal **LCH**

EP302

Stone Washed



Stone Washed Pink **SPK**



Stone Washed Burgundy **SBU**



Stone Washed Sage Green **SSAG**



Stone Washed Green **SGR**



Stone Washed Denim **SDE**



Stone Washed Grey **SGY**



Stone Washed Black **SBL**



EP303

Earth Positive® Full Zip Hoodie



The EP303 is Earth Positive®'s elevated take on the essential zip hoodie redesigned for comfort, made for print, and built to last. Crafted from premium **100% GOTS certified organic cotton fleece**, it delivers softness without synthetics and performance without compromise.

With its **clean silhouette and modern fit**, the EP303 blends everyday comfort with street-ready style. The smooth, natural surface is perfect for decoration, offering consistent results for printers and designers who demand quality and reliability.

No polyester, no microplastics, no greenwashing, just the real thing. The EP303 is part of a new generation of merch: one that speaks to conscious Gen-Z and Millennial audiences who want their apparel to reflect their values.

Contemporary, durable, and fully sustainable, this is more than just a zip hoodie - it's your go-to garment for eco-responsible collections that don't cut corners on style or substance.



[Back to Contents](#)

EP303

Earth Positive® Full Zip Hoodie



Fibre Composition / Yarn Type

100% GOTS Organic Cotton Compact Spun

Fibre Type / Weight

Brushed Fleece 3-ply 8.9 oz/yd² 300 g/m²

Available Sizes

XS S M L XL 2XL 3XL

Origin

India

Size Spec



Size	Width (A)		Length (B)	
	cm	inch	cm	inch
XS	53	20¾	66	26
S	56	22	69	27¼
M	59	23¼	72	28½
L	62	24½	75	29½
XL	65	25½	77	30¼
2XL	68	26¾	79	31
3XL	71	28	81	32

Marlowe
Height 190 cm
Size M
Colour Denim Blue

EP303

Earth Positive® Full Zip Hoodie



Black BL



Burgundy BU



Denim Blue DE



French Navy FRNA



Sport Grey SG



Light Heather LHE



Dark Heather DHE



Faded Pink FPK



EP304

Earth Positive® Half Zip Hoodie



Meet the EP304 our most forward thinking piece yet. With its **bold new cut and elevated details**, this is **merch reimaged** for a generation that values creativity, comfort, and consciousness.

Available in classic black and our exclusive sueded black, the EP304 is made from the softest fabric we've ever produced. That **luxurious feel**? It's not a surface treatment it comes from within. The result of advanced spinning and finishing technology no one else in the industry is doing. This isn't fake softness that fades, it's built into the DNA of the garment.

And despite its plush surface, the EP304 is perfect for print. That's the magic of the sueded finish: **premium hand-feel without compromising on the print clarity**, making it ideal for brands, musicians,

and merch-makers **who want to stand out** without sacrificing their sustainability values.

Crafted from **100% GOTS certified organic cotton** and completely free of polyester or microplastics, the EP304 is low-impact and high-performance. It's fashion-forward, ethically made, and ready to disrupt everything you thought you knew about merch.



EP304

Earth Positive® Half Zip Hoodie



Fibre Composition / Yarn Type

100% GOTS Organic Cotton Compact Spun

Fibre Type / Weight

Brushed Fleece 3-ply 8.9 oz/yd² 300 g/m²

Available Sizes

XS S M L XL 2XL 3XL

Origin

India

Size Spec



Size	Width (A)		Length (B)	
	cm	inch	cm	inch
XS	58	22¾	67.5	26½
S	61	24	70.5	27¾
M	64	25¼	72.5	28½
L	67	26½	74.5	29¼
XL	70	27½	76.5	30
2XL	73	28¾	77.5	30½
3XL	76	30	77.5	30½

Length (B): The length of EP304 has been updated since March 2025 to improve the fit. The old lengths measured XS 63.5, S 66.5, M 68.5, L 70.5, XL 72.5, 2XL 74.5, 3XL 75.5.

Marlowe
Height **190 cm**
Size **M**
Colour **Sueded Black Heather**

EP304

Earth Positive® Half Zip Hoodie



Black **BL**



Sueded Black **SUBL**



Sueded Light Blue Heather **SULBHE**



Sueded Black Heather **SUBLHE**



EP305

Earth Positive® Mock Neck Sweatshirt



Clean, minimal, and distinctly modern, the EP305 Mock Neck Sweatshirt brings a refined twist to a core staple. Featuring a contemporary raised neckline, it offers a subtle yet impactful update to the classic crew.

Made from **100% GOTS certified organic cotton** and constructed in premium 300 g/m² brushed fleece, it strikes the perfect balance between structure and softness.

Whether layered or worn on its own, the EP305 delivers effortless style and comfort.



EP305

Earth Positive® Mock Neck Sweatshirt



Mock neck

Solid metal 'Bullet tip' cord ends

Contemporary fit

100% GOTS Organic Cotton

Ribbed cuffs



Fibre Composition / Yarn Type

100% GOTS Organic Cotton Compact Spun

Fibre Type / Weight

Brushed Fleece 3-ply 8.9 oz/yd² 300 g/m²

Available Sizes

S M L XL 2XL

Origin

India

Size Spec

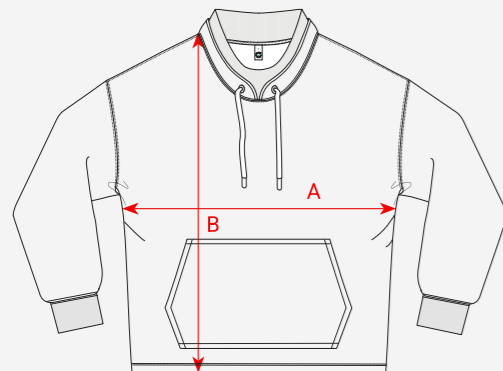

Size	Width (A)		Length (B)	
	cm	inch	cm	inch
S	55	21½	68	26¾
M	58	22¾	71	28
L	61	24	73	28¾
XL	64	25¼	75	29½
2XL	67	26¼	76	30



Johan
Height 184 cm
Size M
Colour Black

EP305

Earth Positive® Mock Neck Sweatshirt



Black BL



Sueded Black SUBL



EP306

Earth Positive® Bomber Jacket Hoodie



The EP306 reimagines a streetwear staple through the Earth Positive® lens. This elevated zip hoodie features a classic bomber-inspired silhouette roomy through the chest, cinched at the waist and cuffs offering a bold yet wearable shape with a modern edge.

Crafted from 300 g/m² brushed-back fleece, the EP306 combines softness and structure in equal measure. A high neck hood, ribbed hem and cuffs, and side-entry pockets with rib detailing complete the look, while the YKK centre front zipper ensures smooth, reliable fastening.

Branded with the signature Earth Positive® woven label at the back neck, this hoodie stands as a statement in both style and sustainability made

from 100% GOTS certified organic cotton with zero polyester or plastic blends.



EP306

Earth Positive® Bomber Jacket Hoodie



High neck hood

Contemporary fit

100% GOTS Organic Cotton

YKK Zipper

Ribbed cuffs and hem



Black BL

Fibre Composition / Yarn Type

100% GOTS Organic Cotton Compact Spun

Fibre Type / Weight

Brushed Fleece 3-ply 8.9 oz/yd² 300 g/m²

Available Sizes

XS S M L XL 2XL

Origin

India

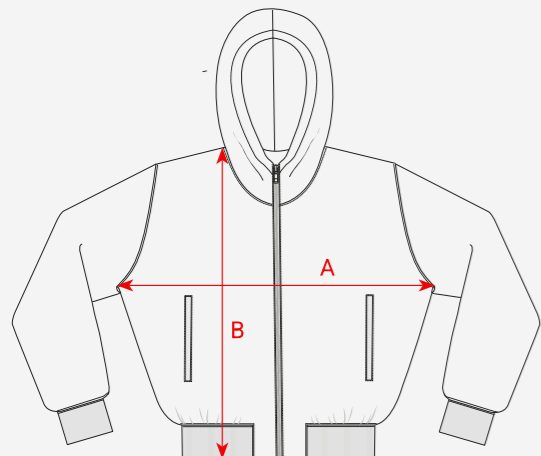

Size Spec

Size	Width (A)		Length (B)	
	cm	inch	cm	inch
XS	61	24	59.5	23½
S	64	25¼	62.5	24½
M	67	26½	64.5	25½
L	70	27½	66.5	26¼
XL	73	28¾	68.5	27
2XL	76	30	69.5	27½

EP307

Earth Positive® 1/4 Zip Sweatshirt



A timeless essential with a premium twist. The EP307 combines the comfort of our signature 300g/m² brushed organic fleece with a clean, contemporary **quarter-zip design**.

Built for layering, it offers a structured yet soft feel, finished with **ribbed cuffs and hem for a snug fit**.

Made from 100% GOTS certified organic cotton and powered by renewable energy, it's the perfect balance of sustainability, quality, and style. Available in: Black, Navy, Black Heather, Light Blue Heather, Dark Heather, Light Heather

from **100% GOTS certified organic cotton** with zero polyester or plastic blends.



EP307

Earth Positive® 1/4 Zip Sweatshirt



High neck collar stand

YKK 1/4 Zipper

Dropped shoulder

100% GOTS Organic Cotton

Contemporary fit

Ribbed cuffs and hem



Black BL



Black Heather BLHE



Dark Heather DHE



Light Blue Heather LBHE



Light Heather LHE



Dark Navy NA

Fibre Composition / Yarn Type

100% GOTS Organic Cotton Compact Spun

Fibre Type / Weight

Brushed Fleece 3-ply 8.9 oz/yd² 300 g/m²

Available Sizes

XS S M L XL 2XL 3XL

Origin

India

Size Spec

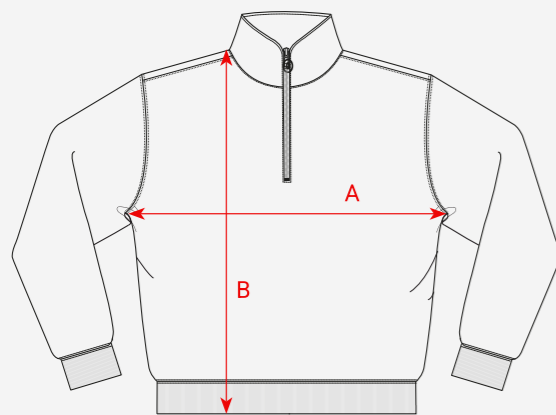

Size	Width (A)		Length (B)	
	cm	inch	cm	inch
XS	58.5	23	64	25¼
S	61	24	66	26
M	63.5	25	68	26¾
L	66	26	70	27½
XL	68.5	27	72	28¼
2XL	71	28	74	29¼
3XL	73.5	29	74	29¼

EP309

Earth Positive® Sleeveless Full Zip Hoodie



A bold silhouette made for layered looks and warmer days the EP309 Sleeveless Hoodie brings a **contemporary edge** to the Earth Positive® fleece range.

Crafted from 300 g/m² sueded fleece in **100% GOTS certified organic cotton**, it delivers soft, structured comfort without any synthetic fibres. The sleeveless cut, paired with a high-neck, double-layer hood, gives it a **streetwear inspired** profile with breathable versatility.

Featuring a kangaroo pocket, ribbed hem, and clean arm openings, the EP309 is designed to work effortlessly as a standalone piece or layered over long sleeves. Whether for activewear collections, fashion drops, or sustainable merch, the EP309

offers a fresh take on fleece, relaxed, modern, and made to last.



EP309

Earth Positive® Sleeveless Full Zip Hoodie



High neck hood

YKK Zipper

100% GOTS Organic Cotton

Pockets

Ribbed hem



Black BL

Light Heather LHE

Dark Heather DHE

Sueded Light Blue Heather SULBHE

Sueded Black Heather SUBLHE

Fibre Composition / Yarn Type

100% GOTS Organic Cotton Compact Spun

Fibre Type / Weight

Brushed Fleece 3-ply 8.9 oz/yd² 300 g/m²

Available Sizes

XS S M L XL 2XL

Origin

India

Size Spec

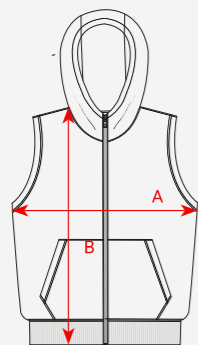

Size	Width (A)		Length (B)	
	cm	inch	cm	inch
XS	49	19¼	65	25½
S	52	20½	68	26¾
M	55	21½	71	28
L	58	22¾	73	28¾
XL	61	24	75	29½
2XL	64	25¼	76	30

EP310

Earth Positive® Shadow Hoodie



The EP310 Shadow Hoodie adds a distinctive tonal finish to the Earth Positive® fleece range, combining elevated style with everyday comfort. Its dip-dye gradient effect gives each garment a soft, sun-faded look - relaxed and unique.

Crafted from 300g/m² sueded fleece in 100% GOTS-certified organic cotton, the EP310 offers soft structure and natural breathability, with no polyester or microplastics.

Designed with a roomy, streetwear-inspired fit, this hoodie features a double-layer hood without drawstrings, a classic kangaroo pocket, and ribbed hem and cuffs for shape. The back neck is finished with the Earth Positive® 'tick' woven label - a clear marker of sustainable production and certified organic materials.



[Back to Contents](#)

EP310

Earth Positive® Shadow Hoodie



Shadow Black SHBL



Shadow Brown SHBR

Fibre Composition / Yarn Type

100% GOTS Organic Cotton Compact Spun

Fibre Type / Weight

Brushed Fleece 3-ply 8.9 oz/yd² 300 g/m²

Available Sizes

XS S M L XL 2XL 3XL

Origin

India

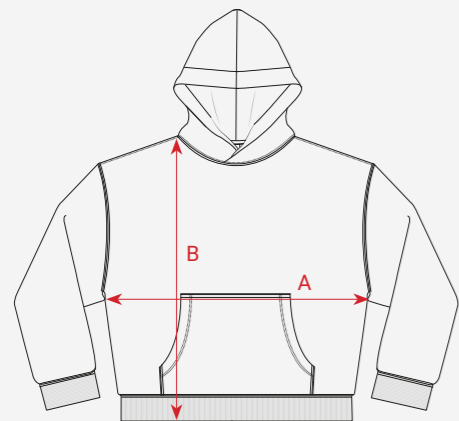

Size Spec

Size	Width (A)		Length (B)	
	cm	inch	cm	inch
XS	57	22½	62	24¾
S	59.5	23½	65	25½
M	62	24½	67	26½
L	64.5	25¼	69	27¼
XL	67	26¼	71	28
2XL	69.5	27¼	73	28¾
3XL	72	28¾	74	29¼

EP311

Earth Positive® Leather Panelled Hoodie



EP311 Leather Panelled Hoodie delivers a sharp, structured look with a premium finish.

Built from 100% GOTS certified organic cotton fleece, it combines soft comfort with a technical edge. Key features are the **unique leather style panel with twin zip pockets, the clean modern hood, dropped shoulders, ribbed cuffs and hem.**

The panel creates a bold contrast that works for streetwear, premium collections, and high impact merch.

No polyester. No microplastics. Earth Positive quality.



[Back to Contents](#)

EP311

Earth Positive® Leather Panelled Hoodie



Self fabric lined hood

100% GOTS Organic Cotton

Leather effect panel

Kangaroo pocket with Zips

Ribbed cuffs and hem



Black Heather BLHE

Fibre Composition / Yarn Type

100% GOTS Organic Cotton Compact Spun

Fibre Type / Weight

Brushed Fleece 3-ply 8.9 oz/yd² 300 g/m²

Available Sizes

XS S M L XL 2XL 3XL

Origin

India

Size Spec

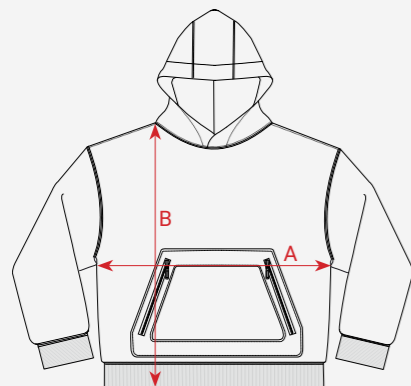

Size	Width (A)		Length (B)	
	cm	inch	cm	inch
XS	53.5	21	62	24¾
S	56.5	22¼	65	25½
M	59.5	23½	67	26½
L	62.5	24½	69	27¼
XL	65.5	25¾	71	28
2XL	68.5	27	72	28¾
3XL	71.5	28¼	72	28¾

EP312

Earth Positive® Short Sleeve Sweatshirt



A fresh take on a classic. The EP312 combines the comfort of a sweatshirt with the ease of a t-shirt, crafted from 300 g/m² brushed 3-ply fleece made of 100% GOTS certified organic cotton.

Designed with a standard fit and short sleeves, it's ideal for layering or for warmer days when you still want that premium fleece feel. Thoughtful details like the back yoke that extends into the sleeves, and ribbed hems on the body and sleeves, elevate its look and structure.

Finished with Earth Positive® branded labels, it's available in six versatile colours, Black, Navy, Black Heather, Light Blue Heather, Dark Heather, and Light Heather.



EP312

Earth Positive® Short Sleeve Sweatshirt



Yoke panel detail

100% GOTS Organic Cotton

Ribbed hem

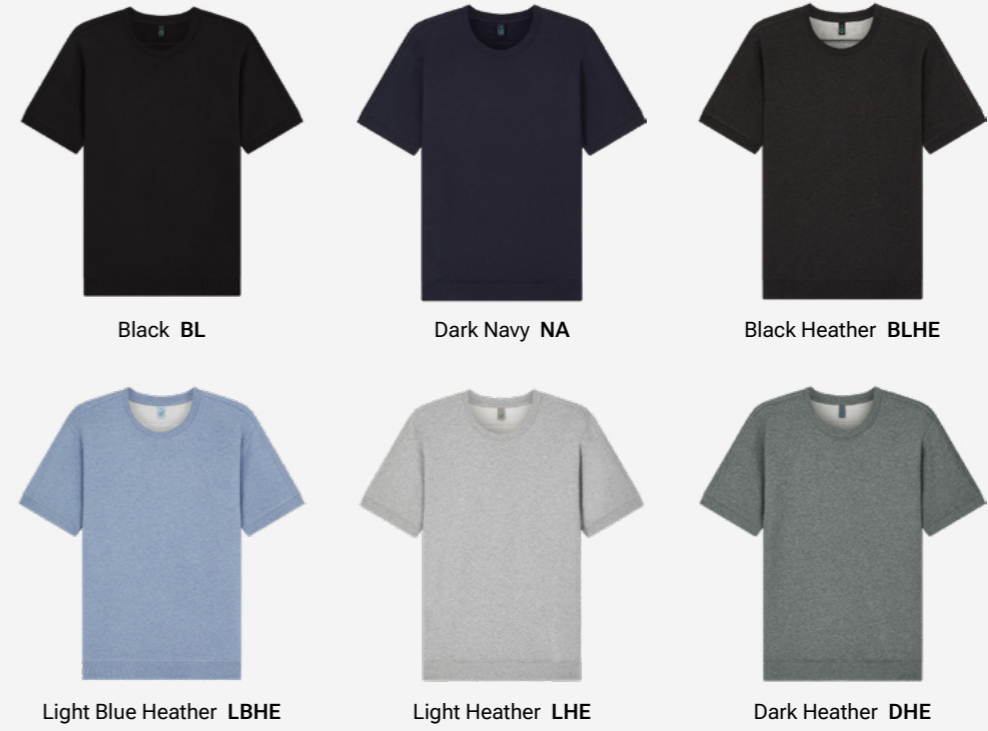

Black BL

Dark Navy NA

Black Heather BLHE

Light Blue Heather LBHE

Light Heather LHE

Dark Heather DHE

Fibre Composition / Yarn Type

100% GOTS Organic Cotton Compact Spun

Fibre Type / Weight

Brushed Fleece 3-ply 8.9 oz/yd² 300 g/m²

Available Sizes

XS S M L XL 2XL 3XL

Origin

India

Size Spec

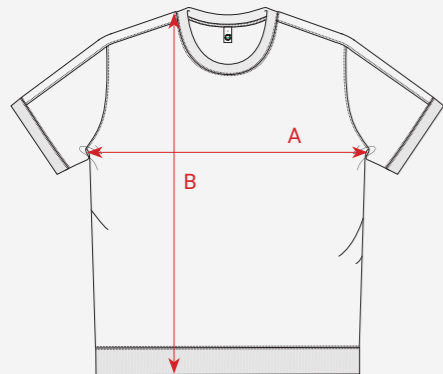

Size	Width (A)		Length (B)	
	cm	inch	cm	inch
XS	49	18¾	67	26½
S	52	20½	70	27½
M	55	21½	72	28¾
L	58	22¾	74	29
XL	61	24	75	29½
2XL	64	25¼	76	30
3XL	67	26½	76	30

EP314

Earth Positive® Women's Half Zip Hoodie



The EP314 is the women's edition of our EP304 hoodie featuring the half-zip opening for **easy wear and elevated style**.

Crafted from 300 g/m² brushed-back fleece in **100% GOTS certified organic cotton**, this piece delivers soft structure and long-lasting comfort.

Designed with a modern fit, it features a high neck collar, ribbed cuffs and hem, and a double-layered hood with no drawstrings for a clean, streamlined look. The sueded finish gives a **luxuriously soft touch, perfect for premium lifestyle and print wear collections**.

Available in 12 rich sueded colours, the EP314 is finished with the Earth Positive® 'tick'

label at the back neck, a mark of ethical and sustainable authenticity.

An essential for sustainable outfitting, casual, comfortable, and built to last. the back neck, a mark of ethical and sustainable authenticity.



EP314

Earth Positive® Women's Half Zip Hoodie



High neck hood

Matching colour Earth Positive® neck label

YKK Half zip

100% GOTS Organic Cotton

Sueded fabric finish

Kangaroo pocket

Ribbed cuffs and hem



Fibre Composition / Yarn Type

100% GOTS Organic Cotton Compact Spun

Fibre Type / Weight

3-ply French Terry Brushed 8.9 oz/yd² 300g/m²

Available Sizes

XS S M L XL 2XL

Origin

India

Size Spec



Size	Width (A)		Length (B)	
	cm	inch	cm	inch
XS	52	20½	60.5	23¾
S	55	21½	62	24½
M	58	22¾	63.5	25
L	61	24	65.5	25¾
XL	64	27½	67.5	26½
2XL	67	26¾	68.5	27

Greta
Height 173 cm
Size S

Colour Sueded Bamboo Green

EP314

Earth Positive® Women's Half Zip Hoodie



Sueded Black **SUBL**



Sueded Off White **SUWM**



Sueded Light Heather **SULHE**



Sueded Fawn **SUFA**



Sueded Pale Lemon **SUPLE**



Sueded Orange **SUOR**



Sueded Miami Pink **SUPR**



Sueded Slate Green **SUSLGR**



Sueded Bamboo Green **SUBGR**



Sueded Blue Dusk **SUBD**



Sueded Light Blue Heather **SULBHE**



Sueded Black Heather **SUBLHE**



Greta
Height 173 cm
Size S

Colour **Sueded Light Heather**

EP316

Earth Positive® Women's Athleisure Hooded Tank



[View Product Online](#)



The EP316 Earth Positive Women's Athleisure Hooded Tank is a unique, new design blending street and urban style with fitness comfort.

Crafted from 100% GOTS certified organic cotton and finished with a luxurious sueded texture, it offers premium softness and Earth Positive quality. Key features include the **modern sleeveless cut, a side pocket, and a special, statement drawstring.** Perfect for streetwear, urban outfits, or yoga and active leisure.

Available in many sueded colours: Sueded Black, Sueded Fawn, Sueded Off White, Sueded Blue Dusk, Sueded Miami Pink, and Sueded Slate Green.



[Back to Contents](#)

EP316

Earth Positive® Women's Athleisure Hooded Tank



Self fabric lined hood

Statement drawstring

Relaxed fit

Sueded fabric finish

Side pocket

Ribbed hem



Sueded Black **SUBL**



Sueded Fawn **SUFA**



Sueded Miami Pink **SUPR**



Sueded Blue Dusk **SUBD**



Sueded Slate Green **SUSLGR**



Sueded Off White **SUWM**

Fibre Composition / Yarn Type

100% GOTS Organic Cotton Compact Spun

Fibre Type / Weight

Brushed Fleece 3-ply 8.9 oz/yd² 300 g/m²

Available Sizes

XS S M L XL 2XL

Origin

India

Size Spec

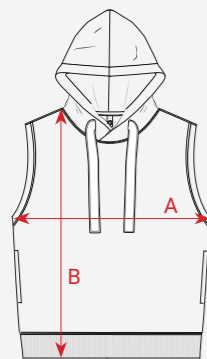

Size	Width (A)		Length (B)	
	cm	inch	cm	inch
XS	51	20	60	23½
S	53.5	21	62	24½
M	56	22	63.5	25
L	58.5	23	65	25½
XL	61	24	66.5	26¼
2XL	63.5	25	66.5	26¼

EP400

Earth Positive® Women's V-Neck Hoodie



The EP400 redefines casual comfort with a feminine edge. This women's V-neck hoodie offers a **flattering neckline** and relaxed fit, crafted from our luxuriously soft 300 g/m² organic cotton fleece.

Designed with **ribbed trims and a double-layer hood**, it delivers both structure and softness - a versatile piece for everyday wear.

Ethically made using 100% GOTS certified organic cotton in renewable energy-powered facilities. Available in: Black, Black Heather, Light Blue Heather, Dark Heather, Light Heather



EP400

Earth Positive® Women's V-Neck Hoodie



Fibre Composition / Yarn Type

100% GOTS Organic Cotton Compact Spun

Fibre Type / Weight

Brushed Fleece 3-ply 8.9 oz/yd² 300 g/m²

Available Sizes

XS S M L XL 2XL

Origin

India

Size Spec

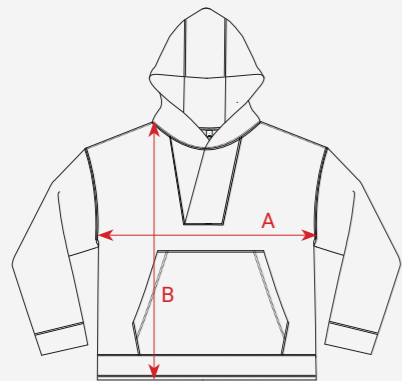

Size	Width (A)		Length (B)	
	cm	inch	cm	inch
XS	49	19¼	61	24
S	51.5	20½	62	24½
M	54	21¼	64	25¼
L	56.5	22¼	66	26
XL	59	23¼	67	26½
2XL	61.5	24½	67	26½

EP400

Earth Positive® Women's V-Neck Hoodie



Black **BL**



Light Heather **LHE**



Dark Heather **DHE**



Light Blue Heather **LBHE**



Black Heather **BLHE**



Greta
Height 173 cm
Size S
Colour **Light Heather**

EP540

Earth Positive® Super Heavy Hoodie



The EP540 is our heaviest hoodie yet, built for those who want unmatched quality, weight, and warmth. Crafted from 100% organic cotton and weighing in at a substantial 540 g/m², this super heavy fleece hoodie delivers maximum comfort with zero compromise.

Designed with a clean, minimal silhouette, the EP540 features a double-layer hood, kangaroo pocket, ribbed cuffs and hem, and drawstrings for a contemporary finish. The high-density fabric creates an exceptional print surface, making it ideal for premium retail, streetwear, or merch applications.

Finished with the EP woven label at the back neck, the EP540 combines heavyweight performance with the Earth Positive® hallmark commitment to sustainability, quality, and low-impact production.

A statement hoodie that looks and feels as strong as its values.



[Back to Contents](#)

EP540

Earth Positive® Super Heavy Hoodie



Black BL

Fibre Composition / Yarn Type

100% GOTS Organic Cotton Compact Spun

Fibre Type / Weight

Loop back 16 oz/yd² 540 g/m²

Available Sizes

XS S M L XL 2XL 3XL

Origin

India

Size Spec



Size	Width (A)		Length (B)	
	cm	inch	cm	inch
XS	53.5	21	66.5	26¼
S	56.5	22¼	70.5	27¾
M	59.5	23½	73.5	29
L	62.5	24½	75.5	29¾
XL	65.5	25¾	77.5	30½
2XL	68.5	27	79.5	31¼
3XL	71.5	28¼	80.5	31¾

EP550

Earth Positive® Colour Panelled Hoodie



The EP550 takes classic hoodie design in a bold new direction. Featuring a striking **two-tone Black and Fawn colourway**, this hoodie brings contrast and character to sustainable fashion.

Crafted from soft brushed organic cotton fleece, it offers a premium feel with durable structure - ideal for both everyday wear and standout collections.

Responsibly made from 100% GOTS certified organic cotton using renewable energy, it's sustainability with edge. A statement hoodie that looks and feels as strong as its values.



EP550

Earth Positive® Colour Panelled Hoodie



Black and Fawn BLFA

Fibre Composition / Yarn Type

100% GOTS Organic Cotton Compact Spun

Fibre Type / Weight

Brushed Fleece 3-ply 8.9 oz/yd² 300 g/m²

Available Sizes

XS S M L XL 2XL

Origin

India

Size Spec

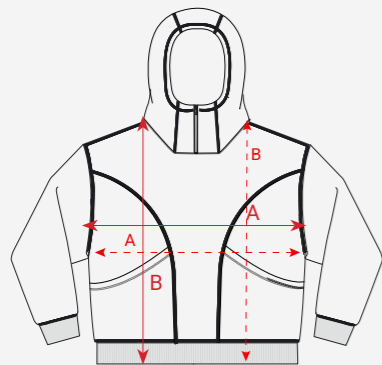

Size	Width (A)		Length (B)	
	cm	inch	cm	inch
XS	55	21½	62	24½
S	57.5	22½	65	25½
M	60	23½	67	26½
L	62.5	24½	69	27¼
XL	65	25½	71	28
2XL	67.5	26½	72	28¾

EP552

Earth Positive® Storm Flap Hoodie



The EP552 pushes hoodie design into new territory merging street-ready style with purposeful construction. Made exclusively in Sueded Black, this standout piece features a unique storm-flap panel across the chest, adding both dimension and protection from the elements.

Crafted from premium brushed organic cotton fleece, the fabric delivers a smooth, sueded finish with a soft, elevated hand-feel. The roomy hood, front kangaroo pocket, and ribbed cuffs and hem offer that everyday comfort you expect - while the distinctive layered look makes it anything but ordinary.

As part of the Earth Positive® collection, the EP552 is produced using 100% GOTS certified organic cotton and renewable energy, ensuring sustainability is built into every stitch.



EP552

Earth Positive® Storm Flap Hoodie



Sueded Black SUBL

Fibre Composition / Yarn Type

100% GOTS Organic Cotton Compact Spun

Fibre Type / Weight

Brushed Fleece 3-ply 8.9 oz/yd² 300 g/m²

Available Sizes

XS S M L XL 2XL

Origin

India

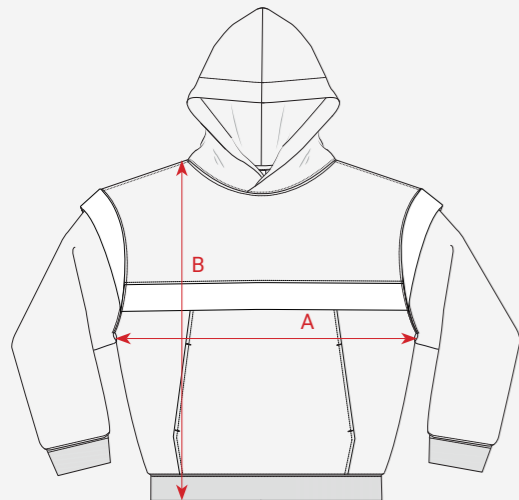

Size Spec

Size	Width (A)		Length (B)	
	cm	inch	cm	inch
XS	53.5	21	63	23¾
S	56.5	22¼	65	25½
M	59.5	23½	67	26½
L	62.5	24½	69	27¼
XL	65.5	25¾	71	28
2XL	68.5	27	72	28¾

Sweatpants, Shorts and Skirts



EP340

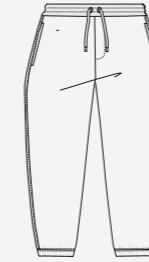

Earth Positive®
Sweatpants

EP341

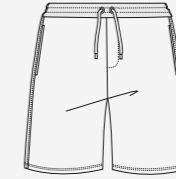

Earth Positive®
Sweat Shorts

EP342

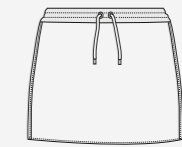

Earth Positive®
Raw Hem Skirt

EP343

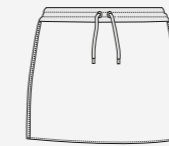

Earth Positive®
Sweat Skirt

EP344

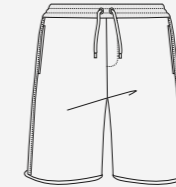

Earth Positive®
Raw Hem Shorts

EP340

Earth Positive® Sweatpants



The EP340 Sweatpants offer **premium comfort with a relaxed, elevated fit** designed to pair effortlessly with other Earth Positive® styles for head-to-toe outfitting.

Crafted from **100% GOTS certified organic cotton**, these sweatpants feature a 300 g/m² sueded fleece with a brushed back for a luxuriously soft feel. The ribbed waistband and adjustable drawstring ensure comfort and flexibility throughout the day.



EP340

Earth Positive® Sweatpants



Ribbed waistband with adjustable drawstring and solid metal 'Bullet tip' cord ends

Side panel detail

100% GOTS Organic Cotton

Sueded fabric finish

Elasticated hem



Fibre Composition / Yarn Type

100% GOTS Organic Cotton Compact Spun

Fibre Type / Weight

3-ply French Terry Brushed 8.9 oz/yd² 300g/m²

Available Sizes

XS S M L XL 2XL

Origin

India

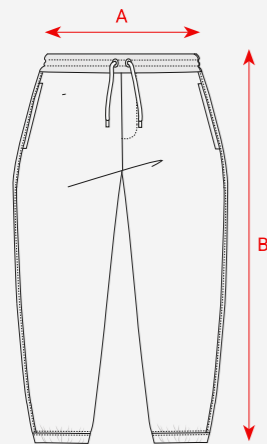

Size Spec

Size	Width (A)		Length (B)	
	cm	inch	cm	inch
XS	34	13½	99	25
S	37	14½	102	40¼
M	40	15¾	105	40¾
L	43	17	106	41¾
XL	46	18	107	42¼
2XL	49	19¾	108	42½



Marlow
Height 190 cm
Size L
Colour **Sueded Black**

EP340

Earth Positive® Sweatpants



Sueded Black **SUBL**



Sueded Light Heather **SULHE**



Sueded Light Beige **SUSA**



Sueded Navy **SUNA**



EP341

Earth Positive® Sweat Shorts



Where comfort meets premium sustainability.

The EP341 Sweat Shorts combine a relaxed, easy fit with a clean, structured design made from ultra-soft 300 g/m² sueded fleece, brushed on the inside for **all-day wearability**.

Body fabric free from **100% GOTS certified organic cotton**, these shorts are entirely free from polyester and microplastics, staying true to Earth Positive's uncompromising environmental standards.

Designed with a ribbed elastic waistband, adjustable drawstring with eyelets, and tipped cord ends, the fit is practical and polished.

Finished with side panels, a subtle back yoke detail, and clean hems, the EP341 delivers premium

feel and structure. A branded woven label at the waistline adds a final touch of authenticity.

Made to complement the broader Earth Positive® range ideal for sustainable fashion, merchandise, and premium printwear.



EP341

Earth Positive® Sweat Shorts



Ribbed waistband with adjustable drawstring and solid metal 'Bullet tip' cord ends

Side pockets

Side panel detail

100% GOTS Organic Cotton

Sueded fabric finish

Twin needle stitching at hem



Fibre Composition / Yarn Type

100% GOTS Organic Cotton Compact Spun

Fibre Type / Weight

3-ply French Terry Brushed 8.9 oz/yd² 300g/m²

Available Sizes

XS S M L XL 2XL

Origin

India

Size Spec

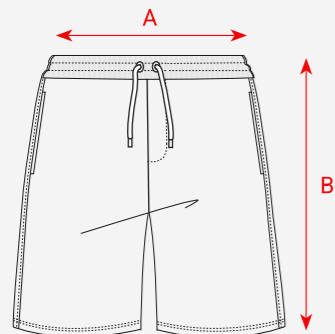

Size	Width (A)		Length (B)	
	cm	inch	cm	inch
XS	34	13½	52	20½
S	37	14½	55	21½
M	40	15¾	58	22¾
L	43	17	59	23¼
XL	46	18	60	23½
2XL	49	19¾	60	23½



Johan
Height **184 cm**
Size **M**
Colour **Sueded Light Beige**

EP341

Earth Positive® Sweat Shorts



Sueded Black **SUBL**



Sueded Light Heather **SULHE**



Sueded Light Beige **SUSA**



Sueded Navy **SUNA**



Sueded Light Blue Heather **SULBHE**



Sueded Black Heather **SUBLHE**



Jude
Height 185 cm
Size M
Colour **Sueded Navy**

EP342

Earth Positive® Raw Hem Skirt



A minimalist update to the EP343, the EP342 features raw-edge hems for a clean, undone finish that leans into contemporary casual styling. It's made from 300 g/m² brushed-back sueded fleece **100% GOTS certified organic cotton** with a **velvety-soft feel** and no polyester or synthetics.

This skirt features a ribbed elastic waistband with bullet-tip drawcords, and a clean side panel detail that adds subtle structure without overcomplicating the silhouette.

Soft, sustainable, and easy to wear, the EP342 adds **effortless versatility** to the Earth Positive® sueded fleece collection built for full outfitting and modern merchandising.



[Back to Contents](#)

EP342

Earth Positive® Raw Hem Skirt



Ribbed waistband with adjustable drawstring and solid metal 'Bullet tip' cord ends

Side panel detail

100% GOTS Organic Cotton

Sueded fabric finish

Raw hem



Fibre Composition / Yarn Type

100% GOTS Organic Cotton Compact Spun

Fibre Type / Weight

3-ply French Terry Brushed 8.9 oz/yd² 300g/m²

Available Sizes

XS S M L XL 2XL

Origin

India

Size Spec

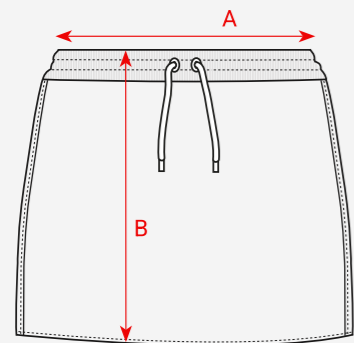

Size	Width (A)		Length (B)	
	cm	inch	cm	inch
XS	31	12¼	37	14½
S	34	13½	38.5	15¼
M	37	14½	40	15¾
L	40	15¾	40	15¾
XL	43	17	40	15¾
2XL	46	18	40	15¾



Ana
Height 174 cm
Size S
Colour **Sueded Black**

EP342

Earth Positive® Raw Hem Skirt



Sueded Black SUBL



May
Height 180 cm
Size S
Colour Sueded Black

EP343

Earth Positive® Sweat Skirt



A new silhouette in the Earth Positive® collection, the EP343 Skirt brings elevated softness and versatility to sustainable outfitting. Crafted from our luxurious 300 g/m² sueded fleece, it combines **premium comfort with a contemporary, streamlined shape.**

This style is designed with a ribbed elastic waistband and bullet-tip drawcords, giving it a clean, minimal finish. Side panels offer subtle shaping, maintaining a flattering fit without added complexity. As with all Earth Positive® styles, it's made from **100% GOTS certified organic cotton** completely free from polyester or synthetics.

Whether styled casually or as part of a coordinated set, the EP343 adds a fresh, wearable layer to any wardrobe.

Available in **10 rich sueded colours**, designed to match across the Earth Positive range. Ideal for sustainable collections in fashion, merch, and premium printwear.



[Back to Contents](#)

EP343

Earth Positive® Sweat Skirt



Ribbed waistband with adjustable drawstring and solid metal 'Bullet tip' cord ends

Side panel detail

100% GOTS Organic Cotton

Sueded fabric finish

Twin needle stitching at hem



Fibre Composition / Yarn Type

100% GOTS Organic Cotton Compact Spun

Fibre Type / Weight

3-ply French Terry Brushed 8.9 oz/yd² 300g/m²

Available Sizes

XS S M L XL 2XL

Origin

India

Size Spec

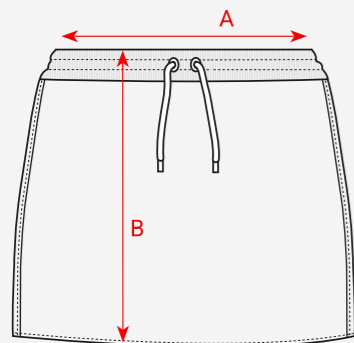

Size	Width (A)		Length (B)	
	cm	inch	cm	inch
XS	31	12¼	37	14½
S	34	13½	38.5	15¼
M	37	14½	40	15¾
L	40	15¾	40	15¾
XL	43	17	40	15¾
2XL	46	18	40	15¾



Ana
Height 174 cm
Size S
Colour Sueded Miami Pink

EP343

Earth Positive® Sweat Skirt



Sueded Black **SUBL**



Sueded Off White **SUWM**



Sueded Light Heather **SULHE**



Sueded Fawn **SUFA**



Sueded Pale Lemon **SUPLE**



Sueded Orange **SUOR**



Sueded Miami Pink **SUPR**



Sueded Slate Green **SUSLGR**



Sueded Bamboo Green **SUBGR**



Sueded Blue Dusk **SUBD**



Sueded Light Blue Heather **SULBHE**



Sueded Black Heather **SUBLHE**



Ana
Height 174 cm
Size S
Colour **Sueded Orange**

EP344

Earth Positive® Raw Hem Shorts



The EP344 takes the core features of our EP341 sweat shorts and adds a subtle, stylish twist: **raw-edge hems** for a relaxed, unstructured look. It's a minimal adjustment that makes a big visual impact ideal for brands seeking a more laid-back, **contemporary style**.

Made from our signature 300 g/m² sueded fleece (100% GOTS certified organic cotton, brushed back), the EP344 offers the same premium softness and eco-conscious credentials as the rest of the sueded range with no polyester or microplastics.

Details include an elasticated ribbed waistband, adjustable drawstring with bullet-tip cord ends, side panels, and subtle back yoke shaping for improved fit and silhouette.

Raw, real, and ready to wear the EP344 expands Earth Positive® outfitting with a clean, modern edge.



[Back to Contents](#)

EP344

Earth Positive® Raw Hem Shorts



Ribbed waistband with adjustable drawstring and solid metal 'Bullet tip' cord ends

Side pocket

Side panel detail

Sueded fabric finish

Raw hem



Sueded Black SUBL

Fibre Composition / Yarn Type

100% GOTS Organic Cotton Compact Spun

Fibre Type / Weight

3-ply French Terry Brushed 8.9 oz/yd² 300g/m²

Available Sizes

XS S M L XL 2XL

Origin

India

Size Spec

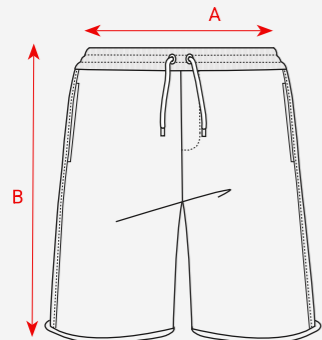

Size	Width (A)		Length (B)	
	cm	inch	cm	inch
XS	34	13½	52	20½
S	37	14½	55	21½
M	40	15¾	58	22¾
L	43	17	59	23¼
XL	46	18	60	23½
2XL	49	19¾	60	23½

Children's Styles



EPJ01



Earth Positive®
Children's T-shirt

EPJ301



Earth Positive®
Children's Hoodie

EPJ304



Earth Positive®
Children's Half Zip Hoodie

EPJ01

Earth Positive® Children's T-shirt



EPJ01 is the children's version of our iconic EP01 the T-shirt that defined Earth Positive®. Made with the same **100% GOTS certified organic cotton** fabric and lightweight 155 g/m² jersey, it delivers all the quality, comfort, and sustainability of the original, perfectly scaled for younger wearers.

This unisex style features a classic fit that's **easy to wear and easy to print on**, making it ideal for schools, events, family merch, or eco-conscious childrenswear brands. Like the adult EP01, we use compact-spun yarn, not enzyme washes to ensure long-lasting softness and shape retention, even after repeated washes.

With fabric that has no polyester, no microplastics, and no compromises, EPJ01 is a go-to for those

who want to offer garments that are **kind to skin and to the planet**.

Whether for custom designs or everyday wear, it's a **small T-shirt with a big message**.



EPJ01

Earth Positive® Children's T-shirt

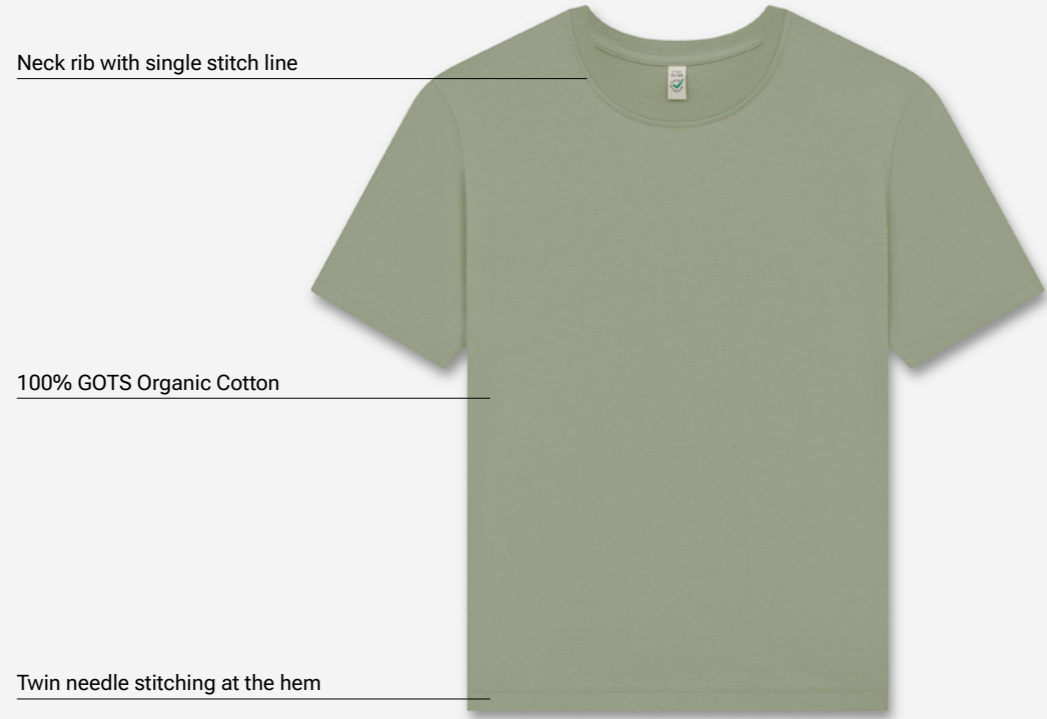

Fibre Composition / Yarn Type

100% GOTS Organic Cotton Compact Spun

Fibre Type / Weight

Jersey 4.6 oz/yd² 155 g/m²

Available Sizes

3-4 yrs 5-6 yrs 7-8 yrs 9-10 yrs 11-12 yrs

Origin

India

Size Spec

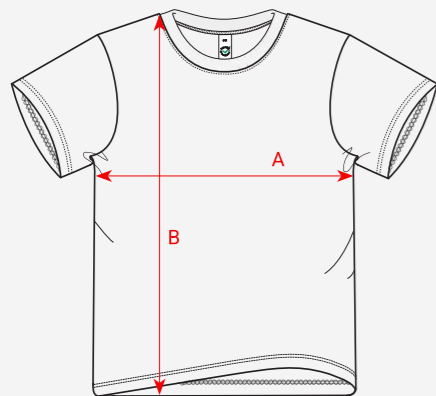

Size	Width (A)		Length (B)	
	cm	inch	cm	inch
3-4 yrs 98-104cm	34	13½	42	16½
5-6 yrs 110-116cm	36	21¼	46	18
7-8 yrs 122-128cm	38	15	50	19¾
9-10 yrs 134-140cm	41	16¼	50	19¾
11-12 yrs 146-152cm	44	17¼	60	23½

Mark
Height 140 cm
Size 9-10 yrs
Colour Faded Denim

EPJ01

Earth Positive® Children's T-shirt



Black BL



White WH



Natural NL



Red RE



Light Blue LB



Bright Blue BB



Faded Denim FDE



French Navy FRNA



Sage Green SAG



Light Olive PGR



Kelly Green KE



Acid Black ABL



Tie Dye Rainbow TD



Tie Dye Blue Green TDBG



EPJ301

Earth Positive® Children's Hoodie



The EPJ301 is the children's version of our best-selling EP301 hoodie, designed with the same **premium quality** and sustainable values now tailored for kids. Crafted from **100% GOTS certified organic cotton fleece**, this hoodie is soft, breathable, and completely free from polyester or synthetic fibres.

It features a double-layered hood (without drawstrings for safety), a front kangaroo pocket, and ribbed cuffs and hem for a snug, durable fit.

Made in a **climate-neutral supply chain** powered by renewable energy and verified fair labour, the EPJ301 is built to stand up to everyday wear while supporting a better future.

Comfortable, reliable, and responsibly made - the EPJ301 is the go-to sustainable hoodie for young wardrobes.



EPJ301

Earth Positive® Children's Hoodie



Fibre Composition / Yarn Type

100% GOTS Organic Cotton Compact Spun

Fibre Type / Weight

3-ply French Terry Brushed 8.9 oz/yd² 300g/m²

Available Sizes

7-8 yrs 9-10 yrs 11-12 yrs

Origin

India

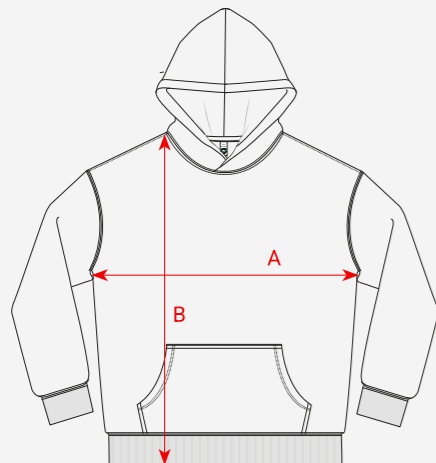

Size Spec

Size	Width (A)		Length (B)	
	cm	inch	cm	inch
7-8 yrs	44.5	17½	50	19¾
9-10 yrs	47.5	18¾	57	22½
11-12 yrs	67	19¾	63	24¾



Savannah
Height 144 cm
Size 9-10 yrs
Colour Sueded Black

EPJ301

Earth Positive® Children's Hoodie



Sueded Black SUBL



EPJ304

Earth Positive® Children's Half-Zip Hoodie



The EPJ304 is the children's version of our EP304 half-zip hoodie built with the same quality, comfort, and sustainability, just scaled for younger wearers.

Made from 300 g/m2 brushed-back fleece using 100% GOTS certified organic cotton, this hoodie is soft, durable, and completely free from polyester or synthetic fibres. Featuring a full-length YKK zipper, double-layer hood (no drawstrings), and front kangaroo pockets, it's a practical, everyday essential with a premium finish.

The ribbed cuffs and hem provide structure and comfort, while the Earth Positive® branded back neck label highlights the garment's ethical, low-impact origin.

Comfortable, reliable, and responsibly made the EPJ304 is ideal for children's collections where sustainability matters.



EPJ304

Earth Positive® Children's Half-Zip Hoodie



Sueded Black SUBL

Fibre Composition / Yarn Type

100% GOTS Organic Cotton Compact Spun

Fibre Type / Weight

3-ply French Terry Brushed 8.9 oz/yd² 300g/m²

Available Sizes

7-8 yrs 9-10 yrs 11-12 yrs

Origin

India

Size Spec

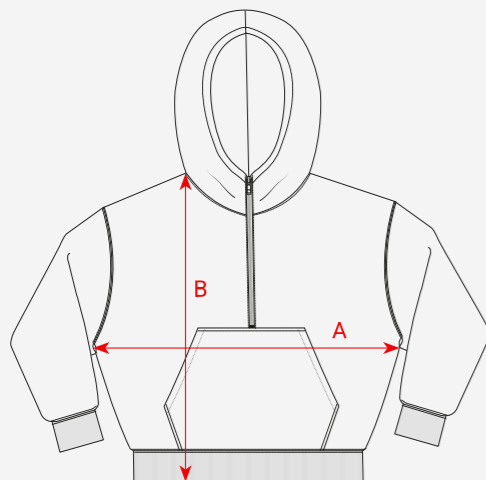

Size	Width (A)		Length (B)	
	cm	inch	cm	inch
7-8 yrs	49	19¼	50	19½
9-10 yrs	52	20½	57	22½
11-12 yrs	55	21½	63	24¾

Tote Bags



EP70

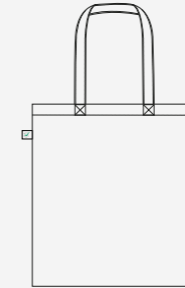

Earth Positive®
Shopper Tote Bag

EP71

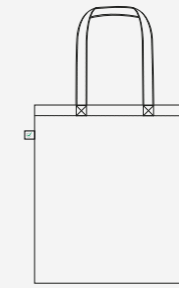

Earth Positive®
Premium Shopper Tote Bag

EP74

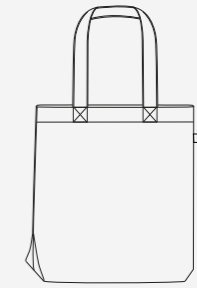

Earth Positive®
Fashion 50/50 Tote Bag

EP75

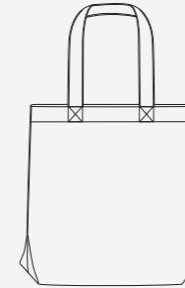

Earth Positive®
Fashion Tote Bag

EP76



Earth Positive®
Drawstring Bag

EP79

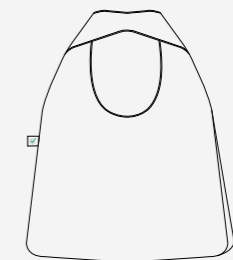

Earth Positive®
Hobo Tote Bag

EP80



Earth Positive®
Heavy Lifter Shopper Bag

EP81

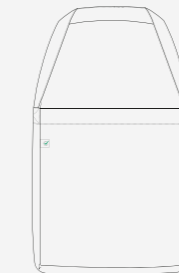

Earth Positive®
Cross Body Bag

EP82

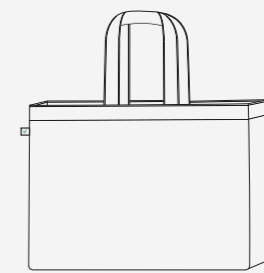

Earth Positive®
Jumbo Tote Bag

EP70

Earth Positive® Shopper Tote Bag



A staple accessory with sustainable credentials, the EP70 is a go-to tote made from 120 g/m², **100% GOTS certified organic cotton**. Durable yet lightweight, it's ideal for daily use, events, or retail merchandising.

With a smooth, printable surface and strong woven handles, it **balances functionality with eco-conscious design**. The side seam features an Earth Positive® flag label, clearly communicating the product's **low-impact, ethical production**.

Designed to align with Earth Positive®'s high sustainability standards with **no polyester, no microplastics, and a climate-neutral supply chain** - this tote is perfect for brands that want to carry their values through every detail. A clean and reliable

blank that looks great with print or embroidery, the **EP70 delivers practical style with purpose.**



EP70

Earth Positive® Shopper Tote Bag



Earth Positive® Flag Label

100% GOTS Organic Cotton

Fibre Composition / Yarn Type
100% GOTS Organic Cotton

Fibre Type / Weight
Plain weave 3.5 oz/yd² 120 g/m²

Available Sizes
One Size

Origin
India

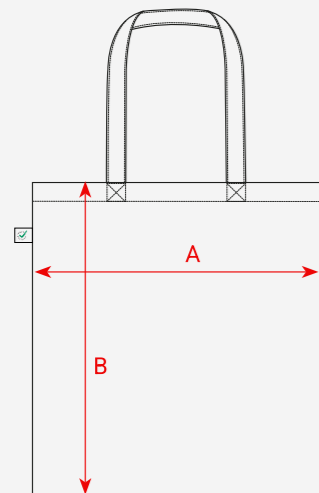

Size Spec

Size	Width (A)		Length (B)	
	cm	inch	cm	inch
One Size	38	15	42	16½

Marlow
Height 190 cm
Size One Size
Colour French Navy



Ana
Height 174 cm
Size One Size
Colour Natural

EP70

Earth Positive® Shopper Tote Bag



Black BL



White WH



Natural (Undyed) NL



French Navy FRNA



Marlowe
Height 190 cm
Size One Size
Colour Black

EP71

Earth Positive® Premium Shopper Tote Bag



A step up in both substance and style, the Earth Positive® Premium Shopper Tote Bag is crafted from heavier 170 g/m² organic cotton, offering **extra durability** while maintaining a smooth, high-quality print surface.

Ideal for retail, merch, and daily use, this tote combines strength, structure, and sustainability in a clean, versatile silhouette. The upgraded fabric provides a more substantial hand-feel than our standard EP70, without sacrificing softness or foldability.

Finished with sturdy handles and a discreet Earth Positive® flag label on the side seam, it visibly reinforces your commitment to ethical, low-carbon production and plastic-free materials. Made from **100% GOTS certified organic cotton** and produced

in a climate-neutral supply chain, this premium tote is built for brands and businesses that want to make a lasting impression sustainably.



EP71

Earth Positive® Premium Shopper Tote Bag



Earth Positive® Flag Label

100% GOTS Organic Cotton



Black BL



White WH

Fibre Composition / Yarn Type
100% GOTS Organic Cotton

Fibre Type / Weight
Plain weave 5 oz/yd² 170 g/m²

Available Sizes
One Size

Origin
India

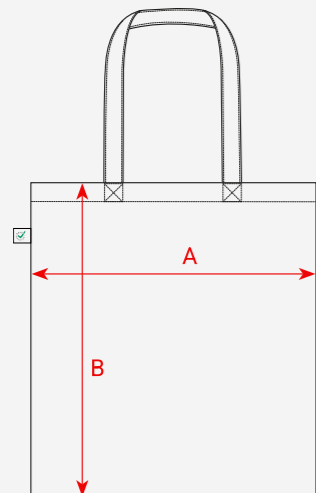

Size Spec

Size	Width (A)		Length (B)	
	cm	inch	cm	inch
One Size	38	15	42	16½

EP74

Earth Positive® Fashion 50/50 Tote Bag



A modern take on the everyday tote, the EP74 blends **50% organic cotton with 50% recycled cotton**, creating a durable, sustainable accessory with a textured, natural feel.

Lightweight yet strong, this fashion-forward bag offers a **stylish silhouette** that's perfect for retail, lifestyle, and event use. The fabric's eco-conscious composition makes it a great fit for brands prioritising **recycled content and circular design**.

Like all Earth Positive® products, the EP74 is made with a climate-neutral supply chain and carries a subtle Earth Positive flag label at the side seam as a mark of authenticity and environmental integrity.

The blend of organic and recycled fibres gives the EP74 its unique appeal: premium in

look and feel, but **grounded in low-impact, responsible manufacturing**.



[Back to Contents](#)

EP74

Earth Positive® Fashion 50/50 Tote Bag



Earth Positive® Flag Label

100% GOTS Organic Cotton

Fibre Composition / Yarn Type
100% GOTS Organic Cotton

Fibre Type / Weight
Plain weave 5 oz/yd² 170 g/m²

Available Sizes
One Size

Origin
India

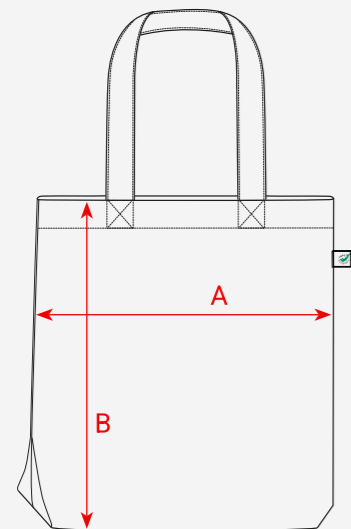

Size Spec

Size	Width (A)		Length (B)	
	cm	inch	cm	inch
One Size	36	14	40	15¾



Ayo
Height 188 cm
Size One Size
Colour Light Olive

EP74

Earth Positive® Fashion 50/50 Tote Bag



Black BL



White WH



Natural (Undyed) NL



Light Beige SA



Blue Dust BD



French Navy FRNA



Light Olive PGR



Ink Grey IG



EP75

Earth Positive® Fashion Tote Bag



A refreshed update to our original EP71, the EP75 Fashion Tote brings **elevated design** and **a wider colour range** to the Earth Positive® accessories collection.

Made from **100% GOTS certified organic cotton**, this tote is lightweight yet durable, offering a clean, modern silhouette perfect for retail, merch, events, or everyday use. Now available in over 10 colourways, it provides more flexibility than ever for brand alignment and customisation.

Like all Earth Positive® products, it's produced in a climate-neutral supply chain, using renewable energy and sustainable farming practices. A subtle Earth Positive® flag label on the side seam communicates the product's ethical and

environmental credentials, a discreet but powerful signifier of quality.

With its eco-friendly build, fashion-forward look, and wide colour palette, the EP75 is a standout choice for conscious brands looking to combine sustainability with style.



[Back to Contents](#)

EP75

Earth Positive® Fashion Tote Bag



Earth Positive® Flag Label

100% GOTS Organic Cotton

Fibre Composition / Yarn Type
100% GOTS Organic Cotton

Fibre Type / Weight
Plain weave 5 oz/yd² 170 g/m²

Available Sizes
One Size

Origin
India

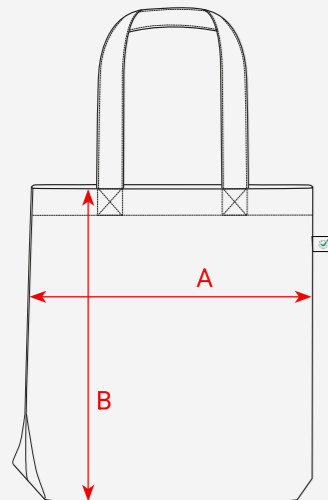

Size Spec

Size	Width (A)		Length (B)	
	cm	inch	cm	inch
One Size	36	14	40	15¾



Marlow
Height 190 cm
Size One Size
Colour Natural

Greta
Height 173 cm
Size One Size
Colour Bright Orange

EP75

Earth Positive® Fashion Tote Bag



Black BL



White WH



Natural (Undyed) NL



Light Beige SA



Blush Pink MP



Pink CP



Cherry Red CHE



Burgundy BU



Cinnamon CI



Bright Orange BOR



Light Denim LD



Faded Denim FDE



Denim Blue DE



French Navy FRNA



Dark Navy NA



Slate Green SLGR



Kelly Green KE



Leaf Green LF



Bottle Green BO



Dark Charcoal DCH



Faded Burgundy (Berry) BE

EP76

Earth Positive® Drawstring Bag



A compact, functional, and sustainable solution for lightweight carrying needs, the EP76 Drawstring Bag is made from **100% GOTS certified organic cotton** in a 170 g/m² plain weave. Strong yet lightweight, it's perfect for daily essentials, promotional use, or eco-conscious retail.

Its simple drawcord closure offers ease of use, while the clean surface provides excellent printability for custom branding. The Earth Positive® flag label on the side seam subtly reinforces the bag's ethical and sustainable production, powered by renewable energy and verified fair working conditions.

Whether for events, campaigns, or everyday convenience, the EP76 is a durable, minimal-impact alternative to synthetic drawstring bags ideal for conscious brands and consumers alike.

[Back to Contents](#)



EP76

Earth Positive® Drawstring Bag



Earth Positive® Flag Label

100% GOTS Organic Cotton

Fibre Composition / Yarn Type
100% GOTS Organic Cotton

Fibre Type / Weight
Plain weave 5 oz/yd² 170 g/m²

Available Sizes
One Size

Origin
India



Johan
Height 184 cm
Size One Size
Colour Natural (Undyed)

Ana
Height 174 cm
Size One Size
Colour Denim Blue

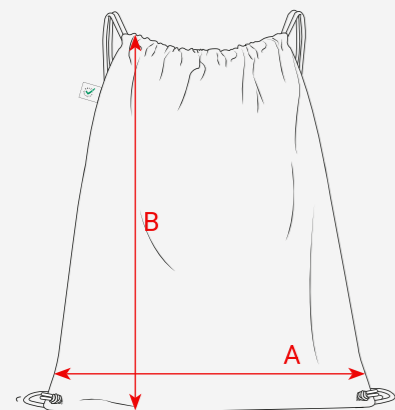

Size Spec

Size	Width (A)		Length (B)	
	cm	inch	cm	inch
One Size	39	15¼	46	18

EP76

Earth Positive® Drawstring Bag



Black BL



Natural (Undyed) NL



Faded Denim FDE



Denim Blue DE



French Navy FRNA



Khaki Green KH



Johan
Height 184 cm
Size M
Colour Faded Denim

EP80

Earth Positive® Heavy Lifter Shopper Bag



Thoughtfully designed for durability and style, the EP80 Heavy Lifter Shopper Bag is made from **100% GOTS certified organic cotton** with a robust **290g/m² canvas weave**, offering exceptional strength for heavy loads and everyday use. This tote combines practicality with sustainability, making it the ideal choice for shoppers, events, or eco-conscious brands.

Its **spacious design** and sturdy construction ensure reliability, while the clean, printable surface is perfect for custom branding. The distinctive Earth Positive® flag label on the side seam highlights the bag's authentic commitment to ethical and sustainable organic production.

Perfect for customers seeking a heavy-duty yet **environmentally responsible tote**, the EP80 stands

out as a premium, low-impact accessory that aligns with conscious consumer values.



[Back to Contents](#)

EP80

Earth Positive® Heavy Lifter Shopper Bag



Fibre Composition / Yarn Type
100% GOTS Organic Cotton

Fibre Type / Weight
Canvas weave 290 g/m² 8.5 oz/yd²

Available Sizes
One Size

Origin
India

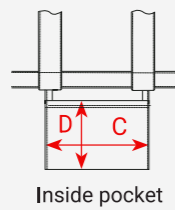
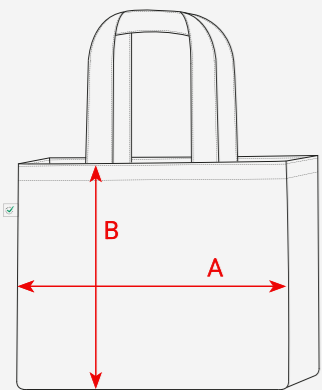

Size Spec

Size	Width (A)		Length (B)	
	cm	inch	cm	inch
One Size	42	16½	35	13¾

Size	Width (C)		Length (D)	
	cm	inch	cm	inch
Pocket	18	7	14	5½



Marlow
Height 190 cm
Size One Size
Colour Black

Devon
Height 173 cm
Size One Size
Colour Natural (Undyed)

EP80

Earth Positive® Heavy Lifter Shopper Bag



Black BL



Natural (Undyed) NL



EP81

Earth Positive® Cross Body Bag



The EP81 Cross Body Bag combines practicality and style with sustainability at its core. Crafted from **100% GOTS certified organic cotton** using a durable 215 g/m² twill weave and compact-spun yarn, this bag offers strength and a refined texture that stands up to everyday use.

Designed for convenience and comfort, it features a **sleek cross-body silhouette perfect for on-the-go lifestyles**. Like all Earth Positive® bags, it carries the distinctive EP flag label on the side seam, a mark of authentic ethical production and low carbon impact.

A **versatile, fashion-forward accessory** that meets your customers' demands for quality, eco-conscious materials, and responsible manufacturing.



EP81

Earth Positive® Cross Body Bag



Earth Positive® Flag Label

100% GOTS Organic Cotton

Fibre Composition / Yarn Type

100% GOTS Organic Cotton

Fibre Type / Weight

Twill weave 6.3 oz/yd² 215 g/m²

Available Sizes

One Size

Origin

India

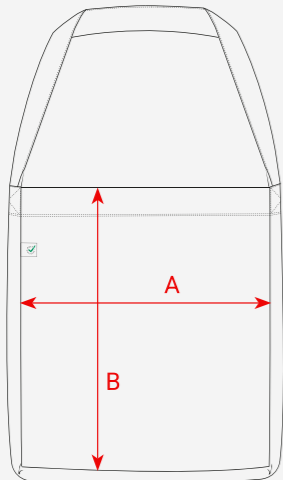

Size Spec

Size	Width (A)		Length (B)	
	cm	inch	cm	inch
One Size	36	14	40	15¾



Marlow
Height 190 cm
Size One Size
Colour Faded Denim

Devon
Height 173 cm
Size One Size
Colour Natural (Undyed)

EP81

Earth Positive® Cross Body Bag



Black BL



Light Beige SA



Faded Denim FDE



Denim Blue DE



Light Charcoal LCH



Faded Burgundy (Berry) BE



EP82

Earth Positive® Jumbo Tote Bag



The **EP82 Jumbo Tote Bag** is the ultimate carry-all oversized, durable, and designed for heavy use. Made from **100% GOTS certified organic cotton canvas** (290 g/m²), it offers a sturdy structure and a large capacity, perfect for everything from daily errands to event giveaways or retail.

The long handles make it easy to wear over the shoulder, while the wide gusseted base provides extra space and support for bulkier items. Like all Earth Positive® bags, it carries the EP side flag, a subtle marker of **certified organic production and low-carbon manufacturing**.

A **high-impact, high-capacity tote** built for sustainable branding and serious utility.



EP82

Earth Positive® Jumbo Tote Bag



Earth Positive® Flag Label

100% GOTS Organic Cotton

Fibre Composition / Yarn Type
100% GOTS Organic Cotton

Fibre Type / Weight
Canvas weave 290 g/m² 8.5 oz/yd²

Available Sizes
One Size

Origin
India

Size Spec

Size	Width (A)		Length (B)	
	cm	inch	cm	inch
One Size	60	23½	40	15¾

Size	Width (C)		Length (D)	
	cm	inch	cm	inch
Pocket	23	9	26	10¼

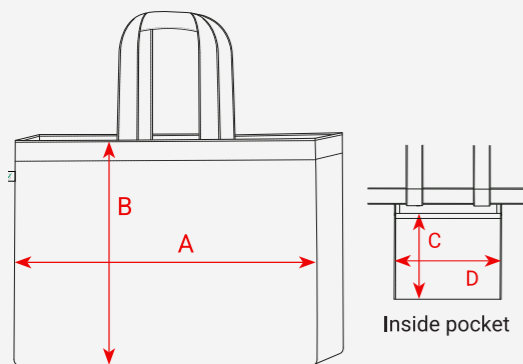

Inside pocket



Johan
Height 184 cm
Size One Size
Colour Natural (Undyed)

Ana
Height 174 cm
Size One Size
Colour Black

EP82

Earth Positive® Jumbo Tote Bag



Black BL



Natural (Undyed) NL



Earth Positive®

Our Colours



Black BL	White WH	Off White WM	Warm White WWH	RFD (Ready For Dye) RFD	Natural (Undyed) NL	Ecru EC	Light Beige (Sand) SA	Bone BON	Blush Pink MP	Powder pink PP	Pink (Candy) CP	Sweet Pink SL	Miami Pink PR	Pink PINK	Red RE
Cherry Red CHRE	Burgundy BU	Rust DO	Cinnamon CI	Bright Orange BOR	Mustard MUS	Burnt Yellow MA	Tie Dye Rainbow TD	Tie Dye Black TDBL	Tie Dye Blue Green TDBG	Light Blue LB	Soft Blue SB	Bright Blue BB	Pastel Blue PBL	Pastel Purple PPU	Light Denim LD
Faded Denim FDE	Denim Blue DE	French Navy FRNA	Dark Navy NA	Petrol Blue PET	Blue Dusk BD	Slate Green SLGR	Sage Green SAG	Light Olive PGR	Kelly Green KE	Leaf Green LF	Bamboo Green BGR	Forest Green FGR	Bottle Green BO	Moss Green MO	Khaki Green KH
Brown BRB	Light Grey GY	Bamboo Light Grey LGY	Sport Grey SG	Light Heather LHE	Dark Heather DHE	Storm Grey STG	Light Charcoal LCH	Charcoal Grey CHGY	Dark Charcoal DCH	Ink Grey IG	Ash Black AB	Acid Black ABL	Sueded Black SUBL	Sueded Off White SUWM	Sueded Light Heather SULHE
Sueded Fawn SUFA	Sueded Light Beige SUSA	Sueded Pale Lemon SUPLE	Sueded Orange SUOR	Sueded Miami Pink SUPR	Sueded Slate Green SUSLGR	Sueded Bamboo Green SUBGR	Sueded Blue Dusk SUBD	Sueded Navy SUNA	Faded White FWH	Faded Pink FPK	Faded Burgundy BE	Faded Burgundy FBU	Faded Khaki FKH	Faded Mustard FMU	Faded Brown FBR
Faded Purple Haze FPH	Faded Navy FNA	Faded Black Deep Grey FBDG	Faded Olive Black FBL	Stone Washed White SWH	Stone Washed Pink SPK	Stone Washed Burgundy SBU	Stone Washed Sage Green SSAG	Stone Washed Green SGR	Stone Washed Denim SDE	Stone Washed Grey SGY	Stone Washed Black SBL	Light Blue Heather LBHE	Black Heather BLHE	Shadowed Brown SHBR	Shadowed Black SHBL
Sueded Black Heather SUBLHE	Sueded Light Blue Heather SULBHE														



EARTH POSITIVE[®]

The Future of Merch